

# PRODUCT INFORMATION

How to extend the life of your TQB Brands Equipment

# TQB

TQB Brands Pty Ltd

# TOP TIPS



Visit our webpage [www.tqbbrands.com.au](http://www.tqbbrands.com.au)  
for instructional & pre-start videos.

**TQ TRADEEQUIP**  
the trusted brand in equipment

**TQ PRO**  
Trusted by serious professionals

**BORUM**  
INDUSTRIAL WORKSHOP EQUIPMENT

# OUR BRANDS

SERVING THE TRADE SINCE 1984



TQB Brands Pty Ltd

## Workshop Equipment Specialist's

TQB Brands has grown to become one of the most respected garage equipment suppliers in Australia and markets the recognised leading brands **TradeQuip**, **TQ Pro**, **Borum** nationally through 1000+ distributors. We offer an extensive range of products including **Garage & Workshop, Industrial, Agricultural and Vehicle Service Equipment**. We continually strive to introduce new and innovative garage and workshop tools and equipment for the professional, which comply with mandatory Australian Standards. TQB Brands aims to achieve great value for money whilst not compromising on quality. TQB Brands prides itself on offering fit for purpose product through our tiered brand offerings.



Our **Flagship** brand of garage and workshop equipment, **TradeQuip** is designed for use in a demanding **garage and workshop** environment by trade users. With proven and trusted "**Made for the Trade**" reliability, **TradeQuip** branded products offer the very best in performance for an affordable price. The **TradeQuip** range is covered by a **12 month trade use warranty**.



Our "**heavy duty commercial**" range of **Borum Industrial** equipment has been manufactured to exacting standards for the past **38 years**. We specify industrial quality components and design to ensure a long and durable working life in **commercial transport, mining, earthmoving and railway** environments. Our **Borum Industrial** range of equipment is focused on achieving superior professional standards, reliability, quality, and are covered by a **12 month trade use warranty**.



Trusted by serious professionals



**LATEST APPLIED TECHNOLOGIES**

**TQ Pro** top quality Tools and Equipment are designed and manufactured for specialist **professional use in a garage and workshop** environment. **TQ Pro** products are strong, reliable, and well finished for the **expert tool user** who appreciates professional design, reliability, and attention to detail. Covered by our **12 month trade use warranty**, our **TQ Pro** Tools & Equipment are made with pride to deliver the best combination of professional performance, presentation, and reliability.





# PRODUCT SUPPORT

## HYDRAULIC GARAGE EQUIPMENT

### ***10 Top Tips***

**to extend the life of your TQB BRANDS Hydraulic Equipment**

#### **Tip#1 Frequent Inspections**

Maintenance of hydraulic Garage Equipment should be carried out 2 to 3 times a year, but, you should inspect it, every time you use it. Before trying to lift a vehicle using the Garage Jack, it should be checked to ensure that everything is in place. Check for any cracks in the frame, leaking & that all of the nuts & bolts are secure and tight.

#### **Tip#2 Keep it Clean**

Hydraulic Garage Equipment should be lubricated using good quality grease and oil. Unfortunately, grease and oils tend to attract dust and dirt, so regular cleaning is vital to extending the service life of all hydraulic Garage Equipment. All that is usually needed, is a piece of clean cloth and automotive silicon to wipe it down when you finish using it. This will prevent dust build up and ensure that the hydraulic Garage Equipment is always ready for next use.

#### **Tip#3 Use Grease and a Heavy Oil (such as gear or differential oil) to Lubricate Moving Parts**

All of the moving parts must be regularly lubricated. Most hydraulic lifting equipment will have mechanisms such as wheels, bearing, linkages and pivots with oiling ports or grease nipples to allow lubrication. Follow your equipment's maintenance manual for lubrication instructions, and lubricate regularly, as this enhances the overall performance. You should apply lubrication to all of the moving parts right after cleaning your Hydraulic Garage Equipment.

#### **Tip#4 Change the Hydraulic Oil**

Another essential tip in making sure that your hydraulic Garage Equipment is maintained properly, is to ensure that the oil is replaced frequently. When replacing the oil, you should be keen to note the exact level of the oil in order to avoid potential damage to hydraulic Garage Equipment due to overfilling.

#### **Tip#5 Bleed (purge) the Cylinder**

Bleeding the cylinder should restore the operating capabilities of hydraulic Garage Equipment. The cylinder should be bled periodically to enhance the hydraulic Garage Equipment's overall performance. One of the main indicators that the cylinder needs bleeding, is when the hydraulic Garage Equipment Pump mechanism feel soft/spongy when under load.

#### **Tip#6 Proper Storage**

Storage is a critical element of proper maintenance for all hydraulic Garage Equipment. Always ensure that the hydraulic Garage Equipment is wiped down and clean before storing it. Release all the pressure in the cylinder, and lower the lifting ram or lift arm, as this will alleviate any stress on the hydraulic system. When storing hydraulic Garage Equipment, always ensure that it is in the upright position and fully lowered. This will prevent the hydraulic oil from seeping through relaxed seals.

#### **Tip#7 Safeguarding the Cylinder from Moisture**

Always make every effort to prevent moisture from getting into the system and mixing with the hydraulic jack oil. Moisture in a hydraulic

system can cause corrosion of the ram, pistons and valves causing possible failure. To prevent moisture from entering the hydraulic system, never leave hydraulic garage equipment outside.

#### **Tip#8 Maintenance Timetable**

Ensure your Garage Equipment is maintained on a regular schedule. When you have a schedule that you are sticking to, contaminants will not build up, and this will help keep your hydraulic Garage Equipment in the best condition. Once the hydraulic Garage Equipment is cleaned, you should store it in a cool dry place.

#### **Tip#9 The Cost of Maintenance Products**

Two of the common items that are required for proper hydraulic Garage Equipment maintenance include grease and hydraulic oil. Never use low-quality hydraulic jack oil or grease as they may end up destroying the overall functionality of hydraulic Garage Equipment. Importantly, never use any fluid other than hydraulic oil. Brake fluid or Auto Trans fluid will dry seals and cause the hydraulic Garage Equipment to fail, voiding any warranty.

#### **Tip#10 "Start Now"- don't wait for it to break!**

By using the tips suggested above, you can extend the lifespan of any piece of hydraulic Garage Equipment and minimize any costly downtime. Even if you have top quality hydraulic Garage Equipment, the key to making it last for a very long time is through regular maintenance. Although the maintenance process for hydraulic Garage Equipment is pretty easy, most people don't perform it. Correct regular maintenance is the main influence of its longevity and durability. Proper maintenance is not rocket science, and everyone can do it.





# PRODUCT SUPPORT

## HYDRAULIC JACKING EQUIPMENT BLEEDING

### WHY DOES HYDRAULIC JACKING EQUIPMENT NEED TO BE BLED?

#### COMMON ISSUES WITH MANUAL AND AIR/MANUAL JACKING EQUIPMENT WHERE BLEEDING IS REQUIRED TO RETURN THE JACK TO OPERATING AS PER SPECIFICATION.

The word "hydraulics" generally refers to force produced by moving liquids within a piston and barrel arrangement. These systems operate by the use of pressurised hydraulic fluid in a sealed hydraulic fluid/air environment using air powered or manual pumps to generate pressure resulting in lifting force.

In normal course of use, the balance of the aforementioned factors needs regular correcting to prevent air ingress. This is achieved through regular maintenance intervals.

Usually, hydraulic issues are not limited to but are most commonly an imbalance of fluid and air levels.

#### **Below includes several reasons this occurs:**

- Equipment that has been operated on an angle beyond manufacturers specifications where the oil pickup point in the reservoir has been exposed to air, can draw air into the pump and require bleeding, e.g. jacking a garage/bottle jack on a unlevel surface or operating a porta power pump with the outlet above the rear of the reservoir.
- Equipment that is low on oil will only extend the lift ram to the corresponding volume of oil in the reservoir, where at that point any further pump strokes will induce air into the pump, porting or valve sets.
- Manual and Air/Manual Jacking equipment such as bottle jacks, garage jacks, scissor lifts, transmission jacks, engine crane rams and porta powers are sealed systems that create a vacuum in the reservoir when extended. If stored extended, this will eventually draw air into the hydraulic system through seals that are in a relaxed state. This type of equipment should always be stored in a fully retracted state after each use to minimise air ingress into the pumps, porting and valve sets.
- Movement of jacking equipment can also cause air pockets to form in pumps, porting and valve sets due to vibration or incorrect stowage during transport e.g. Jack carried on its side.
- Air motor pump systems are affected by all of the above in the same way manual pumps are though usually show only one symptom, that being an air motor that is working but with no advance in the lift ram. These also need to be bled to get back to normal operation.
- New jacking equipment should be bled according to owner's manual instructions before first operation to ensure no air has entered pumps, porting or valve sets during transport.
- Depending on daily use of the equipment mentioned above, it is recommended to bleed equipment:

- Minimum every 90 days
- Drop in lifting performance
- A feeling of sponginess during lifting
- Shuddering during lowering or extending to lift point





# PRODUCT SUPPORT

## TRANSMISSION LIFTER SAFETY

### DO NOT USE YOUR TRANSMISSION LIFTER TO SUPPORT LOADS

The following Safety Information applies to TQB BRANDS Transmission Lift Models 2022T, 2053T, 2063T, 2002T, 2052, 2059T, PROTL500, PROTL1000.

#### USE THESE PRODUCTS FOR THEIR INTENDED PURPOSE ONLY



#### INTENDED USE:

Designed for the removal, installation, and transportation (in the lowered position) of transmissions that are raised by an in-ground or above-ground lift.

Transmission lifters must not be used to support a heavy load such as a differential with axle, accessory equipment and or suspension components.

- Incorrect use as a static load support can be damaging to the transmission lifts ram assembly. Lateral forces can be applied if the supported item raised is attached to the vehicle in a pivot arrangement such as found in suspension components.
- This application can allow lateral force to be applied to the fully extended ram which causes it to jam at or near the top of stroke.
- When this occurs, on lowering of the supported load the ram can be forced at an angle down its barrel tearing the barrel surface. This causes a ledge that if deep enough will seize the retracting ram.
- This issue is caused by extended period of time where the lifter is working as a support. This lifter works where under load the primary piston fully extends first until it reaches its internal stop then the secondary ram extends.
- The transmission lift seals will wear prematurely and therefore fail where the transmission lift is used as a load

support. This is because the seals are under pressure for extended time. The hydraulic seals in the ram assembly can also be compromised where lateral forces of a leaning ram can force the seal to distort under load.

- The TradeQuip 1198T Auxiliary stand should always be used where Suspension and Differential repairs involve component holding during repairs. The solid screw type construction and cradle provide a solid immovable holding platform. Transmission Lift headstocks are designed to carry load that is evenly applied across the headstock upper plate. This is unlike Auxiliary stands that are designed to hold loads in a cradle.



**WARNING**

**INTENDED USE:** Removal & Installation of Transmissions

**NOT INTENDED FOR:** Supporting Loads i.e. Fuel Tanks, Suspension Work, BullBar Installations

# PRODUCT SUPPORT

## FIND US ON YOUTUBE

For a comprehensive guide to your TQB Brands product Maintenance, Setup and Demonstration



**YouTube**  
Scan code to go to TQB Brands Youtube Channel

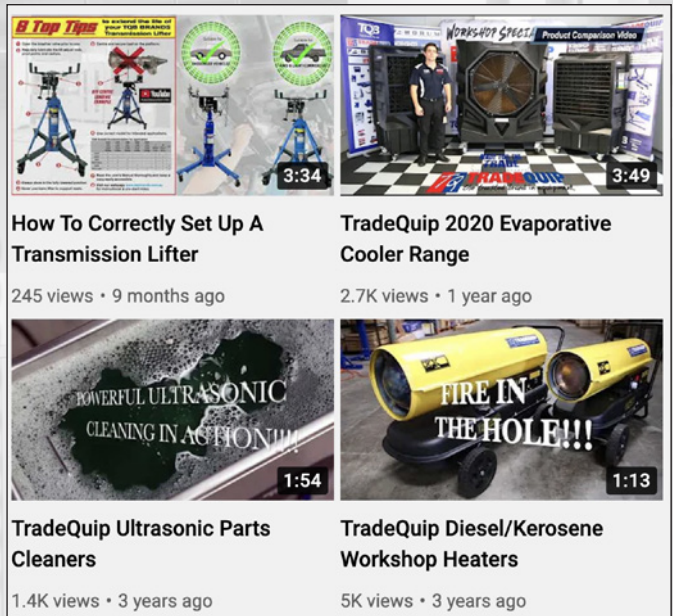

**8 Top Tips**  
To avoid the fine for your MOT BRANCHED Reproduction Lifter  
3:34

**How To Correctly Set Up A Transmission Lifter**  
245 views • 9 months ago

**TradeQuip 2020 Evaporative Cooler Range**  
2.7K views • 1 year ago

**POWERFUL ULTRASONIC CLEANING IN ACTION!!!**  
1:54

**TradeQuip Ultrasonic Parts Cleaners**  
1.4K views • 3 years ago

**FIRE IN THE HOLE!!!**  
1:13

**TradeQuip Diesel/Kerosene Workshop Heaters**  
5K views • 3 years ago

**EXTENSIVE  
PRODUCT SUPPORT  
& INFORMATION  
REGULARLY UPDATED**



**TQB Brands Website**  
Scan code to go to TQB Brands Troubleshooting Documents

### TROUBLESHOOT DOCUMENTS

- BOTTLE JACKS (0)
- BLASTING EQUIPMENT (2)
- CRANES & LIFTING DEVICES (0)
- DRILLING MACHINES (0)
- ENGINE STANDS & SUPPORTS (0)
- FANS, COOLERS, HEATERS & AIRCON (6)
- GARAGE JACKS (25)
- MOTORCYCLE LIFTERS (0)
- OIL DRAINERS & PUMPS (0)
- PARTS WASHERS (2)
- PORTA POWERS & PANEL REPAIR (1)
- PRESSES & PIPE BENDERS (17)
- STANDS, RAMPS & DOLLIES (1)



# PRODUCT INFORMATION

## TQB Brands Hydraulic Cylinder Seal Damage

# Troubleshooting Guide

The following GUIDE applies to TQB Brands Hydraulic Cylinder Seal Damage

**SECTION 1:** Briefly explains some of the forces at work while you are lifting a load with a Jack or Cylinder and explains the risks of sideloading hydraulic cylinders and the subsequent effects on their pistons, ram shafts, load caps, barrels

- The main line of force is through the centre of the Ram Shaft Load Cap or Headstock, loads should be distributed or balanced as close to this centre line as possible.
- The entire base of the jack or cylinder needs to be on a solid and level surface for a stable lift.
- If the load is not centred or the entire face of the Ram Shaft or Headstock does not contact the load, side loading will occur. This creates an unstable setup where loads may shift or fall. Side loading increases with distance, the further you extend the plunger, the more unstable it becomes.
- Side loading causes damage to the Barrel and Piston components such as gouged or scored barrels, pistons, ram shafts, load caps, rolled edges on pistons, and bent ram shafts.

Leaking from reservoir base suggesting off centre loading

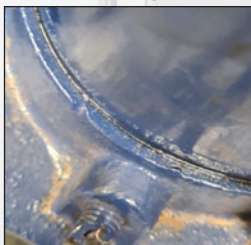

Bent Jack base typically bent at corners



Damaged load cap typically flattened edges or score marks across load surfaces



Dent top of reservoir of damaged return spring saddle



Score marks on the outside of the lift ram and piston



Seal damage & gouged barrel



Load cap load slippage

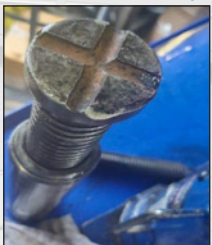

Total side load collapse



Gouged barrel



Scored Ram Shaft



Scored Piston & Seal assembly



**SECTION 2:** Briefly explains the Seal damage seen as a consequence of side loading Ram Shaft / Piston assemblies

- As a consequence of side loading Ram Shaft/Piston Assemblies, their seals will distort under pressure causing a variety of seal damage such as gouged or torn sealing faces causing bypass of hydraulic fluids which can result in the cylinders collapse under load.



Scored Barrel Damage



Gouged Barrel Damage

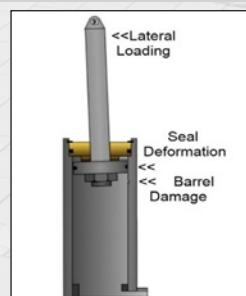

# PRODUCT INFORMATION

## TQB Brands Hydraulic Cylinder Seal Damage

### *Troubleshooting Guide*

The following GUIDE applies to TQB Brands Hydraulic Cylinder Seal Damage

#### SECTION 3: Briefly explains Seal damage due to incorrect hydraulic fluids compatibility and or contamination

- Where hydraulic fluid contamination has occurred via incorrect fluids, seals will exhibit a variety of failure evidence such as ragged edges, blisters, cracks, voids, or discoloration causing seal failure and potential load collapse.
- Rams, Barrels and Cylinders in Jacking systems must be kept clean externally to prevent contamination ingress. The introduction of external flotsam and jetsam into the hydraulic cylinder causes contamination. When particles such as dirt, mud, powder, metallic particles, or other tiny elements attach themselves to the piston and seal, they dirty the seal and become embedded under pressure. The dirtier the seal, the more it loses its ability to seal against associated barrels and ram shafts causing hydraulic bypass and load collapse.



#### SECTION 4: Briefly explains Seal damage due to overloading

- Overloading of Hydraulic Systems can cause damage to seals. This damage is not always immediately evident, and a seal may not fail for a period of time after the overloading event. Where overloading has occurred, we recommend the lift Ram/Cylinder must be "Removed From Service Immediately" for inspection and or repairs.



#### SECTION 5: Symptoms indicating Seal or Ram assembly failure

- Air/Manual pump has no resistance, lift ram will not raise
- Load cannot be sustained; lift ram drops under load
- Load cannot be sustained; lift ram drops under load. Pump handle rises
- Pump has partial resistance; lift ram will not raise to full stroke
- Lift Ram has limited stroke, pump loses resistance
- Ram shaft will not retract under load
- Reservoir / Ram housing leaks from the base
- Base is no longer flat, curved from excessive side loading
- Gouging evidence on ram shaft
- Bent spring saddle
- Load cap gouged across the load surface
- Ram advances but immediately retracts under load



# PRODUCT INFORMATION

## How to extend the life of your Transmission Lifter

### 10 Top Tips

to extend the life of your TQB BRANDS Transmission Lifter

**1** Open the breather valve prior to use.

Opening the breather prior to operation ensures the efficient hydraulic operation of the lift ram and pump preventing pump and ram cavitation resulting in poor operation and or possible hydraulic oil loss.



**2** Regularly lubricate the tilt adjust rods, pivot points.

Lubrication of all pivots, pins, adjusters, and castor wheels ensures smooth operation during lifting and adjustment procedures while removing a transmission.



**3** Regularly lubricate the castors axles & ball races to ensure smooth movement of the loaded jack.



**4** Always store in the fully lowered position.

Storage in the lowered position ensures the lift ram assembly is sealed from exposure to weather fluctuations and keeps the hydraulic ram seals in a relaxed condition ready to work when required.



**5** Never use trans lifter for supporting loads.

To ensure long life of the hydraulic lift ram seals, a load must not be supported above the fully lowered position. Once a transmission is removed from a vehicle the loaded transmission lift must be fully lowered where the internal mechanical travel stops can support the load. Transmission lifts must not be used for suspension support during repairs. Please use a suitable auxiliary stand for this purpose.



**6** Centering the load on the platform.

Correct balance of the load is a critical factor where unbalanced loads can affect the smooth lowering and raising operation. Always consult your vehicle manufacturer specifications for the correct lift point when attaching transmission lifter to a transmission.



**7** Use correct model for intended application.

The following chart explains model suitability based on GVM and Transmission type.

	TQB BRANDS Recommendation for Under Hoist Transmission Jack Applications						2 WHEEL DRIVE	ALL WHEEL DRIVE	4 X 4 & LIGHT COMMERCIAL
	GVM LESS THAN 2000KG	GVM LESS THAN 2300KG	GVM LESS THAN 2500KG	GVM LESS THAN 3200KG	GVM LESS THAN 3500KG				
2049T/59T	Y					Y			
2002T/22T	Y	Y				Y	Y		
2052	Y	Y	Y			Y	Y		
PROTL500	Y	Y	Y			Y	Y		
2053T/63T	Y	Y	Y	Y		Y	Y	Y	
PROTL1000	Y	Y	Y	Y	Y	Y	Y	Y	

**8** Hazards and Obstructions.

All wheeled TQB Brands equipment must be used on smooth surface free of cracks, crevices and tripping hazards that can foul the wheels during operation or relocation.

**9** Read the user Manual thoroughly and keep a copy easily accessible.

The user's manuals are important to the initial set up and ongoing maintenance and come with each transmission jack, they are also downloadable from our webpage at [www.tqbbrands.com.au](http://www.tqbbrands.com.au)

**10** Visit our webpage for instructional videos.

We have created instructional videos for our range of transmission jacks which include bleeding procedures and product comparisons. You'll find these at [www.tqbbrands.com.au](http://www.tqbbrands.com.au)

# PRODUCT INFORMATION

## How to extend the life of your Transmission Lifter

### 7 Top Tips

to extend the life of your  
**TQB BRANDS or BORUM**  
Transmission Lifter

Includes  
Models:  
2081T, 2057T  
& BHDTJ2

**1** Regularly lubricate the tilt adjust rods, pivot points and castors.

Lubrication of all pivots, pins, adjusters, and castor wheels ensures smooth operation during lifting and adjustment procedures while removing a transmission

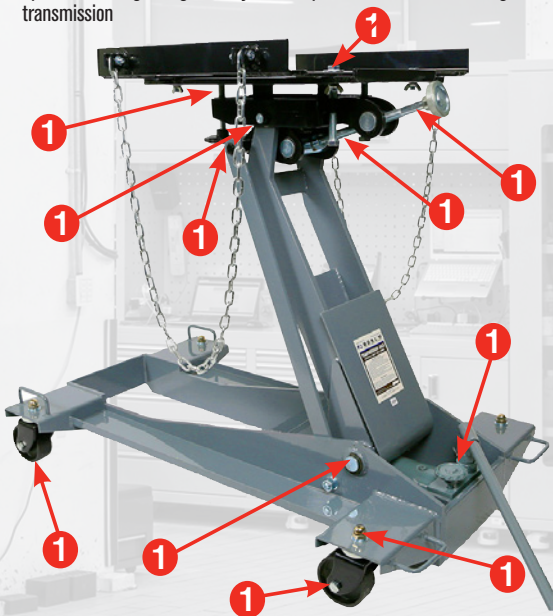

**2** Always store in the fully lowered position.

Storage in the lowered position ensures the lift ram assembly is sealed from exposure to weather fluctuations and keeps the hydraulic ram seals in a relaxed condition ready to work when required.

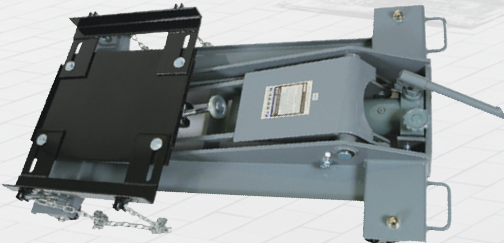

**3** Never use trans lifter for supporting loads.

To ensure long life of the hydraulic lift ram seals, a load must not be supported above the fully lowered position. Once a transmission is removed from a vehicle the loaded transmission lift must be fully lowered where the internal mechanical travel stops can support the load.

**4** Centering & balancing load on the platform.

Correct balance of the load is a critical factor where unbalanced loads can affect the smooth lowering and raising operation. Always consult your vehicle manufacturer specifications for the correct lift point when attaching transmission lifter to a transmission.

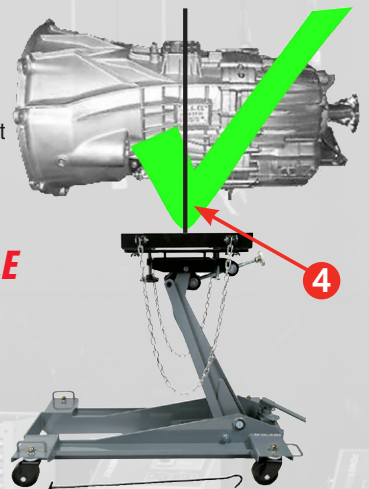

**BALANCED  
LOADING EXAMPLE**



**5** Use correct model for intended applications.

The following chart explains model suitability based on GVM and Transmission type.

TQB BRANDS Recommendation for Application Domestic/Commercial Vehicles								
	GVM LESS THAN 2000KG	GVM LESS THAN 2300KG	GVM LESS THAN 2500KG	GVM LESS THAN 3200KG	GVM LESS THAN 3500KG	TWO WHEEL DRIVE	ALL WHEEL DRIVE	4 X 4
2081T	Y	Y	Y	N	N	Y	N	N
2057T	Y	Y	Y	Y	Y	Y	Y	Y
*BHDTJ2	Y	Y	Y	Y	Y	Y	Y	Y

\* BHDTJ2 is also suitable for use with light to heavy commercial vehicles including agricultural and earthmoving vehicles with transmissions such as Multi Geared Manual, Automated Manual and Automatic such as Allison, Eaton, Fuller, Road Ranger, Dana, Rockwell, Meritor, TTC, Spicer, Volvo, Scania, ZF, Mercedes Benz, Man, Iveco, Isuzu, Mitsubishi FUSO, Hino, UD, Toyota.

Please always consult your Vehicle Manufacturer for suitability and safe practice.

**6** Read the user Manual thoroughly and keep a copy easily accessible.

The user's manuals are important to the initial set up and ongoing maintenance and come with each transmission jack, they are also downloadable from our webpage at [www.tqbbrands.com.au](http://www.tqbbrands.com.au)

**7** Visit our webpage for instructional videos.

We have created instructional videos for our range of transmission jacks which include bleeding procedures and product comparisons. You'll find these at [www.tqbbrands.com.au](http://www.tqbbrands.com.au)



# PRODUCT INFORMATION

## How to extend the life of your Transmission Lifter

### 7 Top Tips

to extend the life of your  
**TQB BRANDS or BORUM**  
Transmission Lifter

Includes  
Models:  
2081T, 2057T  
& BHDTJ2

**1** Regularly lubricate the tilt adjust rods, pivot points and castors.

Lubrication of all pivots, pins, adjusters, and castor wheels ensures smooth operation during lifting and adjustment procedures while removing a transmission

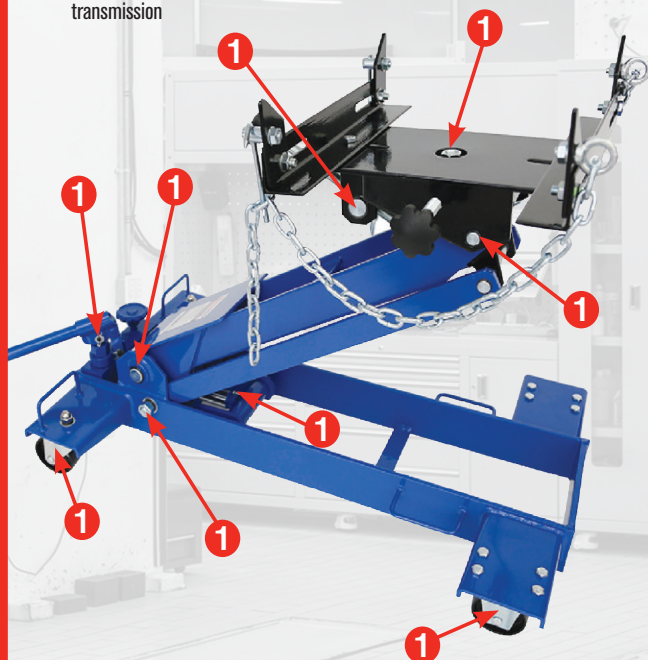

**2** Always store in the fully lowered position.

Storage in the lowered position ensures the lift ram assembly is sealed from exposure to weather fluctuations and keeps the hydraulic ram seals in a relaxed condition ready to work when required.



**3** Never use trans lifter for supporting loads.

To ensure long life of the hydraulic lift ram seals, a load must not be supported above the fully lowered position. Once a transmission is removed from a vehicle the loaded transmission lift must be fully lowered where the internal mechanical travel stops can support the load.

**4** Centering & balancing load on the platform.

Correct balance of the load is a critical factor where unbalanced loads can affect the smooth lowering and raising operation. Always consult your vehicle manufacturer specifications for the correct lift point when attaching transmission lifter to a transmission.

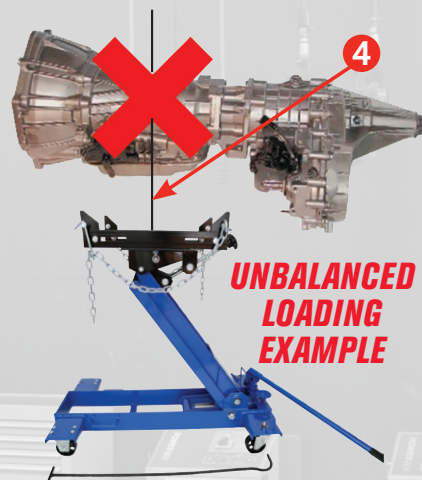

**5** Use correct model for intended applications.

The following chart explains model suitability based on GVM and Transmission type.

TQB BRANDS Recommendation for Application Domestic/Commercial Vehicles								
	GVM LESS THAN 2000KG	GVM LESS THAN 2300KG	GVM LESS THAN 2500KG	GVM LESS THAN 3200KG	GVM LESS THAN 3500KG	TWO WHEEL DRIVE	ALL WHEEL DRIVE	4 X 4
2081T	Y	Y	Y	N	N	Y	N	N
2057T	Y	Y	Y	Y	Y	Y	Y	Y
*BHDTJ2	Y	Y	Y	Y	Y	Y	Y	Y

\* BHDTJ2 is also suitable for use with light to heavy commercial vehicles including agricultural and earthmoving vehicles with transmissions such as Multi Geared Manual, Automated Manual and Automatic such as Allison, Eaton, Fuller, Road Ranger, Dana, Rockwell, Meritor, TTC, Spicer, Volvo, Scania, ZF, Mercedes Benz, Man, Iveco, Isuzu, Mitsubishi FUSO, Hino, UD, Toyota.  
Please always consult your Vehicle Manufacturer for suitability and safe practice.

**6** Read the user's Manual thoroughly and keep a copy easily accessible.

The user's manuals are important to the initial set up and ongoing maintenance and come with each transmission jack, they are also downloadable from our webpage at [www.tqbbrands.com.au](http://www.tqbbrands.com.au)

**7** Visit our webpage for instructional videos.

We have created instructional videos for our range of transmission jacks which include bleeding procedures and product comparisons. You'll find these at [www.tqbbrands.com.au](http://www.tqbbrands.com.au)



# PRODUCT INFORMATION

## How to extend the life of your Evaporative Cooler

### *ii Top Tips*

to extend the life of your TradeQuip Evaporative Coolers

Includes Models: 1027T, 1029T, 1035T

- 1** Prior to any maintenance make sure the unit is switched off and unplugged from the mains electricity supply socket.

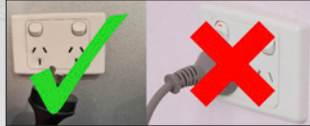

- 2** Empty the reservoir prior to maintenance to provide access to all components.  
*We recommend emptying & refreshing the water every 5-7 days.*



- 3** Lubricate the castor axles and ball race to ensure smooth movement when positioning your evaporative cooler.



- 4** Lubricate vertical louvre pivots and louvre drive linkage with an inert spray lube such as Silicone Lube to ensure long life of the mechanism.

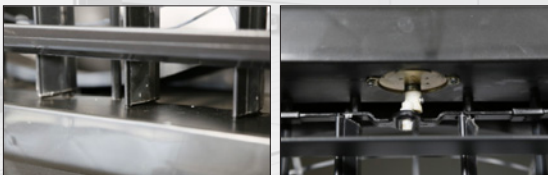

- 5** Inspect unit every 2-3 weeks by removing the dust proof netting and cooling pad and rinse with water [garden hose] then leave in the sun to dry before refitting. This ensures adequate air flow for evaporative function and prevents clogging of the cooling pad.

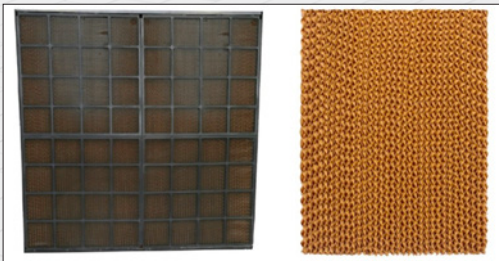

- 6** While the Dustproof Netting & cooling pad are removed, we recommend an inspection & cleaning of the Pump, Water Distributor and Float level Sensor using a soft cloth or medium bristle brush.  
*We recommend emptying & refreshing the water every 5-7 days.*



- 7** To prevent algae build-up, we recommend the use of chlorine or bromine tablets to be added to the reservoir. Make sure you consult the tablet manufacturer for evaporative cooler compatibility and dosage specifications.



- 8** When using the semi-permanent float valve water connection, we recommend not to over tighten the fittings & to check the position of the float valve prior to filling. The float must be pointing towards the opposite bottom corner of the reservoir when empty & pointing towards the opposite top side when full & will pivot between these positions as water level fluctuates.  
*We recommend emptying & refreshing the water every 5-7 days.*

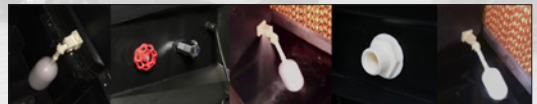

- 9** Hazards and Obstructions.

All wheeled TQB Brands equipment must be used on smooth surface free of cracks, crevices and tripping hazards that can foul the wheels during operation or relocation.

- 10** Whilst not in use for extended periods we recommend following the cleaning steps five to six outlined above leaving the reservoir empty and dry and ready for use next season. For additional protection we recommend our Evaporative cooler cover available through our distributor network.



- 11** Read the user Manual thoroughly and keep a copy easily accessible or visit our webpage [www.tqbbrands.com.au](http://www.tqbbrands.com.au) for instructional documents & pre-start videos.



# PRODUCT INFORMATION

## How to extend the life of your Spot Cooling Air Conditioner

### 8 Top Tips

to extend the life of your TradeQuip Industrial Spot Cooling Air Conditioners

Includes Models: 1031T, 1032T, 1033T

- 1** Prior to any maintenance make sure the unit is switched off and unplugged from the mains electricity supply socket.

NOTE: The electricity supplies required per model are as follows.  
1031T Runs on 240V 10A circuit  
1032T Runs on 240V 15A circuit  
1033T Runs on 240V 15A circuit



- 2** Emptying the Condensation Tank.

A 5 Litre polyethylene condensation tank in the lower-front compartment of the unit collects evaporator-coil condensation moisture.



When full, simply remove and drain.

- 3** During high humidity conditions the condensation tank will need to be emptied more frequently.

To alleviate this the Condensation Tank also comes with an optional Drain Pipe which can be installed. For information on installation instructions consult your owner's manual or at [www.tqbbrands.com.au](http://www.tqbbrands.com.au)

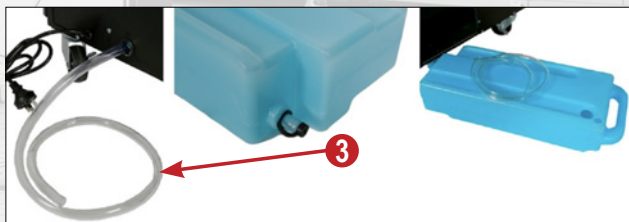

- 4** Clean the filter screen regularly using a vacuum cleaner to remove dust and dirt.

When required the filter screen can be cleaned with a cloth and luke warm water. Do not use chemicals. Leave to dry in a shaded area before reinstalling.

NOTE: For effective cooling clean the filter at least every 2 weeks.



- 5** Lubricate the castor axles and ball race to ensure smooth movement when positioning your TradeQuip Spot Cooling Air Conditioner.



- 6** Correct positioning of your TradeQuip Spot Cooling Air Conditioner is crucial to providing adequate ventilation to prevent overheating and or restricted air flow.

When the appliance is running, ensure the filter screen and the cold air ducting are 300mm minimum from the wall or other obstacles, and the hot exhaust pipe is 900mm minimum from the ceiling or other obstacles.

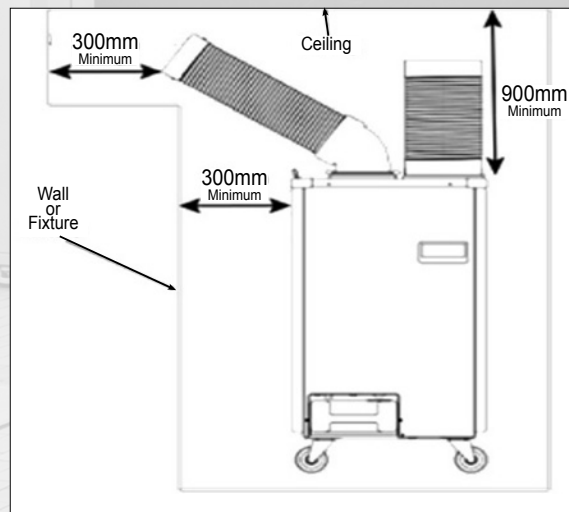

- 7** Always turn the machine off before moving it. If only moved over a very short distance ie within workshop, wait 3 minutes before restarting the machine. If transported for an extended period of time, or after first set up, allow 3 hours for the unit to settle prior to use.
- 8** Read the user Manual thoroughly and keep a copy easily accessible or visit our webpage [www.tqbbrands.com.au](http://www.tqbbrands.com.au) for instructional documents & pre-start videos.

# PRODUCT INFORMATION

## How to extend the life of your Bottle Jacks

### 9 Top Tips

to extend the life of your  
**TQB BRANDS Borum, TQPro,  
Tradequip Air/Hyd Bottle Jacks**

Includes Models:  
BWBBJ20T/30T, BBJ35TA,  
PROBJ20TA/30TA/20TAS,  
BTSJ20TB, TQBJ20TAS/  
12TA, 2051T, 2026T.

#### 1 Ensure Hydraulic oil is at correct levels.

Follow individual model owner's manual instructions for maintenance in your owner's manual provided and also available on our webpage at [www.tqbbrands.com.au](http://www.tqbbrands.com.au)



#### 2 Regularly lubricate the Air motor and Manual Pump Pivots.

Lubrication of the air motor and manual pump pivots, pins, is essential for smooth operation while raising a vehicle.

10ml SAE 32 grade Oil or Air Tool Lubricant.



#### 3 Never use bottle jack for supporting loads.

To ensure long life of the hydraulic lift ram seals, a load must not be supported above the fully lowered position. Once vehicle is raised it must be supported with a load appropriate vehicle stand with the jack lowered and not supporting load.

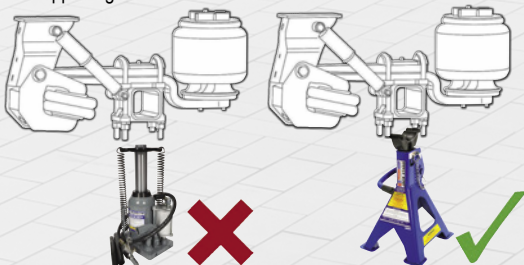

#### 4 Use the available screw extension or solid extension inserts where applicable.

Single piston & multi piston telescopic jacks have their greatest stability from the fully lowered height to 85% of total extended height. Where lowered height of the jack is lower than the load points height from the ground the extension screws & or solid extension inserts should always be used to close the clearance between jack & load point, this also greatly reduces the potential of lateral force.



#### 5 Always consult your vehicle manufacturer specifications for the correct lift point.

Never lift from a suspension pivot or air bag mount plate where these items are designed to travel in an arc causing excess lateral force to the jack throughout its lift cycle.

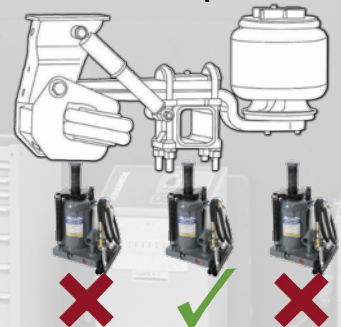

#### 6 Always store in the fully lowered position.

Correct storage is vital to the longevity of your TQB Brands Air/Hydraulic Bottle jack. Always store the Bottle jack with the ram fully retracted to prevent corrosion and contamination ingress.



#### 7 Hydraulic system bleeding.

During transport it is possible that air can become trapped in the hydraulic system, causing poor lifting performance. Refer to your jack models manual for bleeding instructions.

#### 8 Read the user Manual thoroughly and keep a copy easily accessible.

#### 9 Visit our webpage [www.tqbbrands.com.au](http://www.tqbbrands.com.au) for instructional documents & pre-start videos.



# PRODUCT INFORMATION

## How to extend the life of your Hydraulic Garage Jack

### 9 Top Tips

### to extend the life of your TQB BRANDS Hydraulic Garage Jack

- 1** Regularly lubricate all wheels, pivot points and castors.



- 2** Trolley type Garage Jacks must be used on a smooth horizontal surface.

Garage Jacks rely on a smooth flat horizontal surface as when the lift arm is raising the load the jack must be able to roll forward as the centre of gravity of the load shifts.

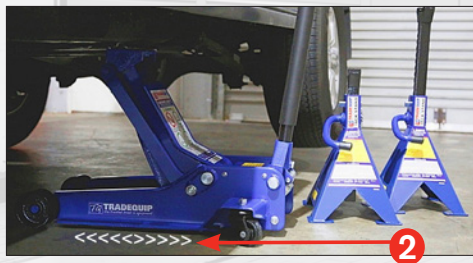

- 3** Load Balancing.

When raising a vehicle from an axle to place on stands the correct balanced lifting point must be used to prevent tipping or load collapse.



- 4** Always store in the fully lowered position.

Storage in the lowered position ensures the lift ram assembly is sealed from exposure to weather fluctuations and keeps the hydraulic ram seals in a relaxed condition ready to work when required.



- 5** Never use the Garage Jack for supporting loads.

To ensure long life of the hydraulic lift ram seals, the jack must be used only to raise a vehicle for the purpose of lowering on to vehicle stands prior to commencement of vehicle maintenance. Always consult your vehicle manufacturer specifications for the correct lift and stands points.

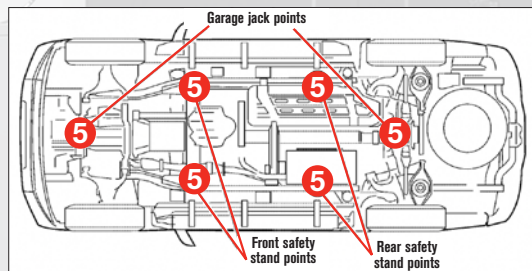

- 6** Hazards and Obstructions.

All wheeled TQB Brands equipment must be used on smooth surface free of cracks, crevices and tripping hazards that can foul the wheels during operation or relocation.

- 7** Use the 2906T for the intended application.

The following chart explains model suitability based on GVM.

TQB BRANDS Recommendation for Application Domestic/Commercial Vehicles								
	GVM LESS THAN 2000KG	GVM LESS THAN 2300KG	GVM LESS THAN 2500KG	GVM LESS THAN 3200KG	GVM LESS THAN 3500KG	TWO WHEEL DRIVE	ALL WHEEL DRIVE	4 X 4
2906T	Y	Y	Y	Y	Y	Y	Y	Y

Please always consult your Vehicle Manufacturer for suitability and safe practice.

- 8** Read the user Manual thoroughly and keep a copy easily accessible.

Manuals are important to the initial set up & ongoing maintenance & come with each Hydraulic Garage Jack, they are also downloadable from our webpage at [www.tqbbrands.com.au](http://www.tqbbrands.com.au)

- 9** Visit our webpage for instructional Videos.

We have created instructional videos for our range of garage jacks which include bleeding procedures, maintenance, and product comparisons. You'll find these at [www.tqbbrands.com.au](http://www.tqbbrands.com.au)

Scan QR codes for maintenance and bleeding instructions.





# PRODUCT INFORMATION

## How to extend the life of your Ratchet Jack Stand

### *10 Top Tips*

to extend the life of your TradeQuip Ratchet Jack Stand

Includes Models: 1128T, 1148T, 1162T

#### 1 At assembly and prior to use, the Ratchet Locking Tab or Bolt must be secured.

Secure the ratchet bar into the frame by bending the locking tab inwards using a hammer and punch on the 1128T/1148T or tighten the bolt on the 1162T. This will help prevent inadvertent separation of the ratchet bar from the base frame during vehicle support setup.

1128T/1148T 1162T

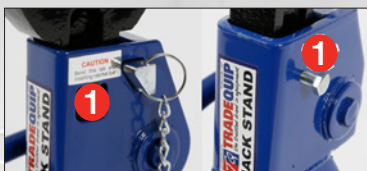

#### 6 Correct Placement.

Vehicle Stands should always have the load cradle centrally positioned on the vehicle lift points. Consult the vehicle manufacturer for lifting and vehicle stand loading points prior to elevating or supporting a vehicle.

Vehicle loading points must remain within the cradle support area



#### 2 Regularly lubricate ratchet mechanism including, pivot points, ratchet teeth and ratchet pawl.

Lubrication of all pivot points, ratchet teeth and ratchet pawl to ensure smooth operation while adjusting to the height clearances of a raised vehicle and provides a positive locking of the mechanism when under load. We recommend a light weight general purpose spray grease.

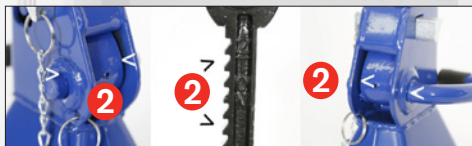

#### 3 TradeQuip 2- and 4-ton stands come with a secondary locking device.

Once the correct height is set insert the locking pin prior to lowering a vehicle onto the stand.



#### 4 TradeQuip Ratchet Jack Stands must be used on a smooth horizontal surface.

Ratchet Jack Stands rely on a smooth flat horizontal surface to remain stable and minimise lateral forces. When raising a vehicle from an axle to place on stands the correct balance point must be used to prevent tipping or load collapse.



#### 5 Securing the Vehicle.

A vehicle must have the park brake applied and the wheels chocked prior to raising to place a vehicle stand. Vehicle stands can only be used to support one end of a vehicle. The stability of a vehicle on stands is critical to the safety of personnel conducting repairs.



#### 7 Garage Jacks are NOT substitutes for Vehicle Stands.

Jacks must be used only to raise a vehicle for the purpose of lowering on to Vehicle Stands prior to commencement of vehicle maintenance.



#### 8 Personal Safety.

No persons should be in a vehicle that is supported by Vehicle Stands. Engine must be turned off. Testing of Drivetrain or running of Engines whilst a vehicle is on stands can create vibration and potential tipping of the vehicle.

#### 9 Read the user Manual thoroughly and keep a copy easily accessible.

Manuals are important to the initial set up and ongoing maintenance and come with each Vehicle Stand pair, they are also downloadable from our webpage at [www.tqbbrands.com.au](http://www.tqbbrands.com.au)

#### 10 Visit our webpage for instructional Videos.

We have created instructional videos for our range of Vehicle Stands including maintenance, and product comparisons. You'll find these at [www.tqbbrands.com.au](http://www.tqbbrands.com.au)



# PRODUCT INFORMATION

## How to extend the life of your Engine Crane

### 9 Top Tips

### to extend the life of your TQB BRANDS 1001T Engine Crane

- 1** Ensure all assembly bolts and fasteners are positioned correctly and tightened before use.

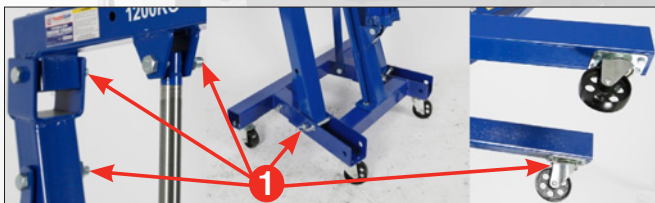

- 2** Regularly lubricate all castors and wheels for ease of movement once loaded.

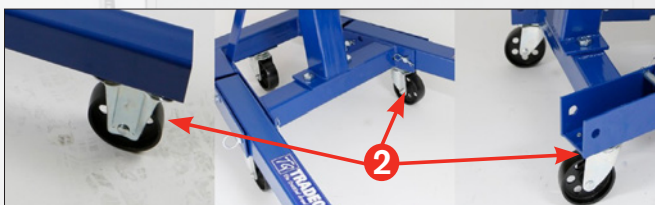

- 3** Using an engine crane once assembled starts with a two-step process. First consult the vehicle manufacturer for load weights then step two, consult the TQB Brands Engine Crane Owner's Manual for correct load jib positioning prior to loading the engine crane.



\* Overloading can cause serious damage to crane components and or injury to operator.

Dimensions	
W1	250kg
W2	500kg
W3	750kg
W4	1,200kg
h1	2300mm
h2	2170mm
h3	2025mm
h4	1890mm
L1	1580mm
L2	1405mm
L3	1220mm
L4	1040mm
L(mm)	1660mm
H (mm)	1485mm

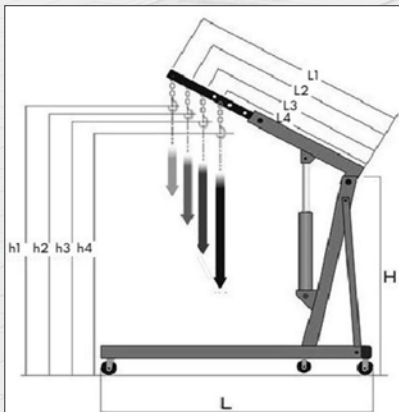

- 4** Off centre loading and unbalanced loads or loads that mount outside of the crane's footprint can cause tipping over of the crane.

Where a combined engine/gearbox extraction and installation is required, we recommend using the shortest position of the jib to decrease risk of tipping.



- 5** Use the jib settings to create a balanced load within the footprint of the crane. Load should always remain within the footprint of the crane to ensure stable manoeuvring and prevent potential forward tipping of the load and crane. **Best Practice Example where a 300kg load should be raised within the cranes footprint for best stability**



- 6** Correct storage is vital to the longevity of the cranes ram. Always store the crane with the ram fully retracted to prevent corrosion and contamination ingress.



- 7** Hazards and Obstructions.

All wheeled TQB Brands equipment must be used on smooth surface free of cracks, crevices and tripping hazards that can foul the wheels during operation or relocation.

- 8** During transport it is possible air has become trapped in the hydraulic system, causing poor lifting performance.

Bleed any air from the system by fully opening the release valve (turn handle counter clockwise as shown), then while holding the boom down, operate pump handle rapidly several times.

- 9** Read the user Manual thoroughly and keep a copy easily accessible or visit our webpage [www.tqbbrands.com.au](http://www.tqbbrands.com.au) for instructional documents & pre-start videos.

# PRODUCT INFORMATION

## How to extend the life of your Engine Crane

### 8 Top Tips

### to extend the life of your TQB BRANDS 1193 Engine Crane

- 1** Ensure all assembly bolts and fasteners are positioned correctly and tightened before use.



- 2** Regularly lubricate all castors and wheels for ease of movement once loaded.



- 3** Using an engine crane once assembled starts with a two-step process. First consult the vehicle manufacturer for load weights then step two, consult the TQB Brands Engine Crane Owner's Manual for correct load jib positioning prior to loading the engine crane.

\* Overloading can cause serious damage to crane components and or injury to operator.

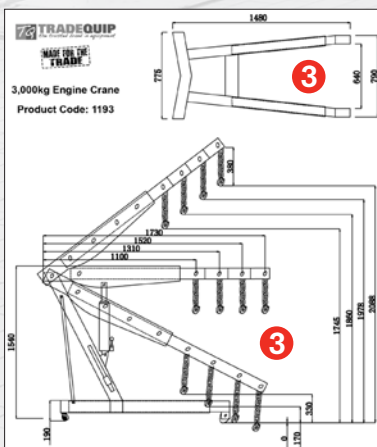

- 4** Off centre loading & unbalanced loads or loads that mount outside of the crane's footprint can cause tipping over of the crane.

Where a combined engine/gearbox extraction is required, we recommend using the shortest position of the jib to decrease risk of tipping. Use the jib settings to create a balanced load within the footprint of the crane. Load should always remain within the footprint of the crane to ensure stable manoeuvring and prevent potential forward tipping of the load and crane.

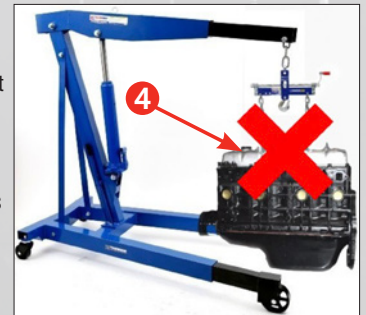

- 5** Hazards and Obstructions.

All wheeled TQB Brands equipment must be used on smooth surface free of cracks, crevices and tripping hazards that can foul the wheels during operation or relocation.

- 6** Correct storage is vital to the longevity of the cranes ram.

Always store the crane with the ram fully retracted to prevent corrosion and contamination ingress.



- 7** During transport it is possible that air has become trapped in the hydraulic system, causing poor lifting performance.

Bleed any air from the system by fully opening the release valve (turn handle counter clockwise as shown), then while holding the boom down, operate pump handle rapidly several times.

- 8** Read the user Manual thoroughly and keep a copy easily accessible or visit our webpage [www.tqbbrands.com.au](http://www.tqbbrands.com.au) for instructional documents & pre-start videos.



# PRODUCT INFORMATION

## How to extend the life of your Air Actuated Truck Jack

### 8 Top Tips

### to extend the life of your TQB BRANDS TradeQuip & Borum Air Actuated Truck Jack

Models 2004T, B2003T, BTJ35TA, BTJ50TA.

#### 1 Ensure Hydraulic oil is at correct levels.

Follow individual model owner's manual instructions for maintenance in your owner's manual provided and also available on our webpage at [www.tqbbrands.com.au](http://www.tqbbrands.com.au)



Remove Filler Bung and if required, refill with SAE 32 grade Hydraulic Oil until the oil is lapping the bottom of the filler hole.

#### 2 Never use the Truck Jack for supporting loads.

To ensure long life of the hydraulic lift ram seals, a load must not be supported above the fully lowered position. Once a vehicle is raised it must be supported with a load appropriate vehicle stand with the jack lowered and not supporting load.

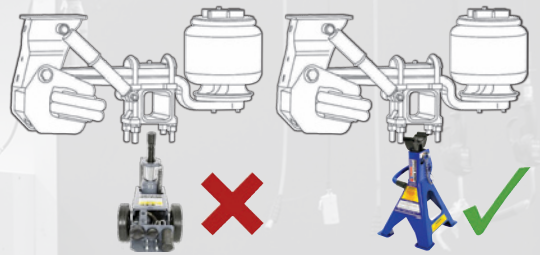

#### 3 Use the available screw extension or solid extension inserts where applicable.

Single piston telescopic jacks have their greatest stability from the fully lowered height to 85% of total extended height. Where the lowered height of the jack is lower than the load points height from the ground the extension screws and/or solid extension inserts should always be used to close the clearance between jack and load point. This also greatly reduces the potential of lateral force.

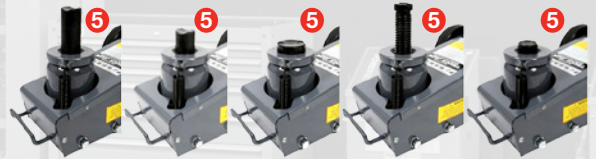

#### 4 Off centre loading or unbalanced loads can affect the smooth lowering & raising operation.

Always consult your vehicle manufacturer specifications for the correct lift point. Never lift from a suspension pivot or air bag mount plate where these items are designed to travel in an arc causing excess lateral force to the jack throughout its lift cycle.

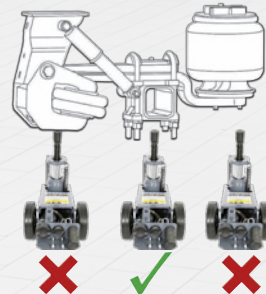

#### 5 Hazards and Obstructions.

All wheeled TQB Brands equipment must be used on smooth surface free of cracks, crevices and tripping hazards that can foul the wheels during operation or relocation.

#### 6 Read the user Manual thoroughly and

keep a copy easily accessible or visit our webpage [www.tqbbrands.com.au](http://www.tqbbrands.com.au) for instructional documents & pre-start videos.

#### 2 Regularly lubricate the Air motor.

Lubrication of the Air motor is essential for smooth operation while raising a vehicle.



#### 3 Always store in the fully lowered position.



Storage in the fully lowered position ensures the lift ram assembly and pump piston is sealed from exposure to weather fluctuations and keeps the hydraulic ram and pump seals in a relaxed condition ready to work when required.



# PRODUCT INFORMATION

## How to extend the life of your Air Actuated Truck Jack

### 9 Top Tips

to extend the life of your TQB BRANDS Borum Air Actuated Truck Jacks

Includes Models: BTJ1530TAM, BTJ1530TA, BTJ60TA, BTJ1025TA, BTJ2550TA, BTJ5080TA, BTJ102550TA, BTJ204060TA, BTJ30TA, BTJL2040TA.

#### 1 Ensure Hydraulic oil is at correct levels.



Follow the BTJ Series relevant owner's manual instructions for maintenance, also available as a download on our webpage at [www.tqbbrands.com.au](http://www.tqbbrands.com.au)

#### 2 Regularly lubricate the Air motor.

Lubrication of the Air motor is essential for smooth operation while raising a vehicle.



*Air motors require a minimum of 20ml of a suitable lubricant such as SAE 32 Grade Hydraulic Oil or Air Tool Lubricant at weekly intervals dependant on usage where daily/constant use may require lubrication more frequently. Please apply directly into the air trigger mechanism air supply coupling.*

#### 3 Always store in the fully lowered position.

Storage in the fully lowered position ensures the lift ram assembly and pump piston is sealed from exposure to weather fluctuations and keeps the hydraulic ram and pump seals in a relaxed condition ready to work when required.



#### 4 Hazards and Obstructions.

All wheeled TQB Brands equipment must be used on smooth surface free of cracks, crevices and tripping hazards that can foul the wheels during operation or relocation.

#### 5 Never use Truck Jack for supporting loads.

To ensure long life of the hydraulic lift ram seals, a load must not be supported above the fully lowered position. Once a vehicle is raised it must be supported with a load appropriate vehicle stand with the jack lowered and not supporting load.

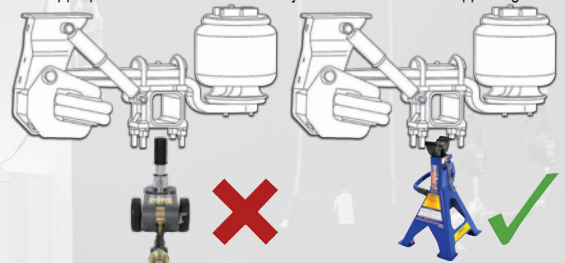

#### 6 Use the available solid extension inserts where applicable.

Single piston telescopic jacks have their greatest stability from the fully lowered height to 85% of total extended height. Where the lowered height of the jack is lower than the load points height is from the ground, the solid extension inserts should always be used to close the clearance between jack and load point, this also greatly reduces the potential of lateral force.



#### 7 Off centre loading or unbalanced loads can affect the smooth lowering & raising operation.

Always consult your vehicle manufacturer specifications for the correct lift point. Never lift from a suspension pivot or air bag mount plate where these items are designed to travel in an arc causing excess lateral force to the jack throughout its lift cycle.

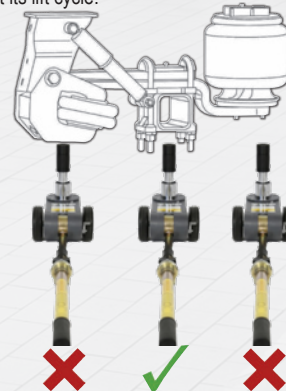

#### 8 Read the user Manual thoroughly and keep a copy easily accessible.

#### 9 Visit our webpage [www.tqbbrands.com.au](http://www.tqbbrands.com.au) for instructional documents & pre-start videos.



# PRODUCT INFORMATION

## How to extend the life of your Truck Jack

### 8 Top Tips

to extend the life of your TQB BRANDS TradeQuip & Borum Air Actuated Truck Jack

#### 1 Ensure Hydraulic oil is at correct levels.

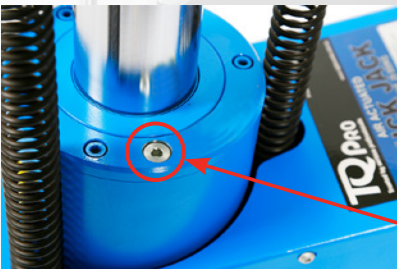

Follow the PROTRJA20T owner's manual instructions for maintenance, also available as a download on our webpage at [www.tqbbrands.com.au](http://www.tqbbrands.com.au)

#### 4 Never use Truck Jack for supporting loads.

To ensure long life of the hydraulic lift ram seals, a load must not be supported above the fully lowered position. Once a vehicle is raised it must be supported with a load appropriate vehicle stand with the jack lowered and not supporting load.

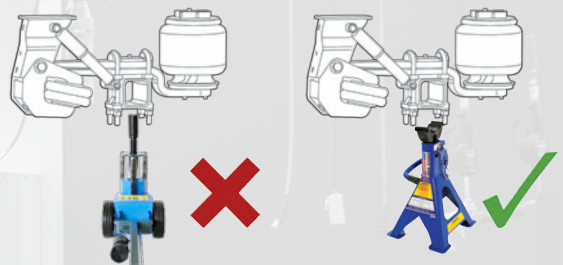

#### 2 Regularly lubricate the Air motor.

Lubrication of the Air motor is essential for smooth operation while raising a vehicle.

Air motors require a minimum of 20ml of a suitable lubricant such as SAE 32 Grade Hydraulic Oil or Air Tool Lubricant at weekly intervals dependant on usage where daily/constant use may require lubrication to occur more frequently, please apply directly into the air trigger mechanism air supply coupling.



#### 5 Use the available screw extension or solid extension inserts where applicable.

Single piston telescopic jacks have their greatest stability from the fully lowered height to 85% of total extended height. Where the lowered height of the jack is lower than the load points height from the ground the extension screws and/or solid extension inserts should always be used to close the clearance between jack and load point. This also greatly reduces the potential of lateral force.



#### 3 Always store in the fully lowered position.

Storage in the fully lowered position ensures the lift ram assembly and pump piston is sealed from exposure to weather fluctuations and keeps the hydraulic ram and pump seals in a relaxed condition ready to work when required.



#### 6 Always consult your vehicle manufacturer specifications for the correct lift point.

Off centre loading or unbalanced loads can affect smooth lowering and raising operation. Always consult your vehicle manufacturer specifications for the correct lift point. Never lift from a suspension pivot or air bag mount plate where these items are designed to travel in an arc causing excess lateral force to the jack throughout its lift cycle.

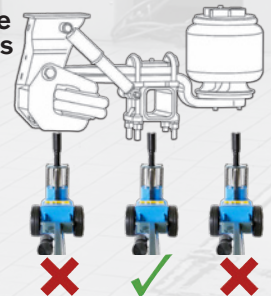

#### 7 Hazards and Obstructions.

All wheeled TQB Brands equipment must be used on smooth surface free of cracks, crevices and tripping hazards that can foul the wheels during operation or relocation.

#### 8 Read the user Manual thoroughly and keep a copy easily accessible. Or visit our webpage [www.tqbbrands.com.au](http://www.tqbbrands.com.au) for instructional documents & pre-start videos.

# PRODUCT INFORMATION

## How to extend the life of your 500kg Auxiliary Lifter

### 9 Top Tips

to extend the life of your **TQB BRANDS** Auxiliary Lifter

Includes Models: 2058T, 2068T

#### IMPORTANT INFORMATION

**NOT INTENDED FOR SUPPORTING LOADS AND NOT INTENDED AS A STAND-ALONE TRANSMISSION LIFTER**

- 1** The TradeQuip 2058T and 2068T are designed as a lifting & aiding device for use in suspension, exhaust components and installation and removal of miscellaneous items such as fuel tanks.



- 2** **Open the breather valve prior to use.**  
Opening the breather prior to operation ensures the efficient hydraulic operation of the lift ram and pump preventing pump and ram cavitation resulting in poor operation and or possible hydraulic oil loss.



- 3** **Regularly lubricate the Ram Gland, Pivot Points and Castors**

Regular application of lubrication of all pivots, pins, adjusters, castor wheels and the grease nipple installed at the ram gland will ensure smooth operation during raising and lowering.



- 4** **Hazards and Obstructions.**  
All wheeled TQB Brands equipment must be used on smooth surface free of cracks, crevices and tripping hazards that can foul the wheels during operation or relocation.

- 5** **Always store in the fully lowered position.**  
Storage in the lowered position ensures the lift ram assembly is sealed from exposure to weather fluctuations and keeps the hydraulic ram seals in a relaxed condition ready to work when required.

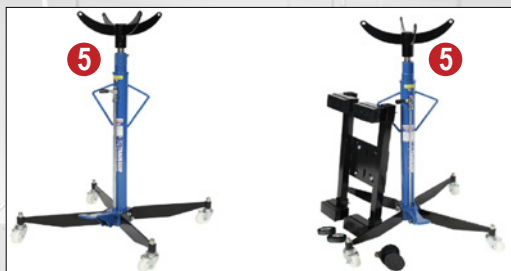

- 6** **Cleanliness equals safety and long life.**  
Cleanliness equals safety and long life from your equipment and its accessories. Regular cleaning of dirt and dust from your auxiliary lifters mechanical fixtures, accessories and attachments will ensure long life and safe operation.

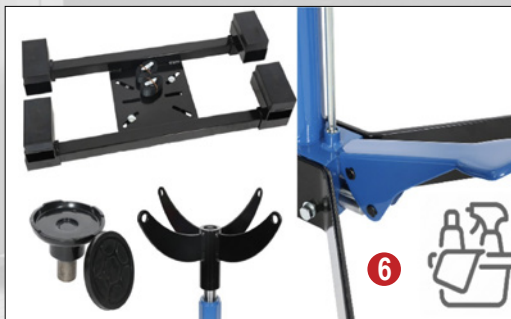

- 7** **Long term load holding.**  
Where long term load holding is required, we recommend the use of our 1198T 650Kg Capacity Mechanical Under Hoist Auxiliary Stand.



- 8** **Read the users Manual thoroughly and keep a copy easily accessible.**

The users manuals are important to the initial set up and ongoing maintenance and come with each Auxiliary Lift, they are also downloadable from our webpage at [www.tqbbrands.com.au](http://www.tqbbrands.com.au)

- 9** **Visit our webpage for instructional videos.**  
We have created instructional videos for our range of Hydraulic equipment which include bleeding procedures and product comparisons. You'll find these at [www.tqbbrands.com.au](http://www.tqbbrands.com.au)



# PRODUCT INFORMATION

## How to extend the life of your Heavy Vehicle Stand

### 8 Top Tips

to extend the life of your **TQB BRANDS Borum Pin Type Vehicle Stand**

Includes Models:  
15TJS,  
15TJSSHORT,  
25TJS,  
25TJSSHORT

#### 1 Regularly lubricate the Centre Column.

Lubrication of the centre column allows for smooth height positioning. We recommend a light application of a general-purpose grease.

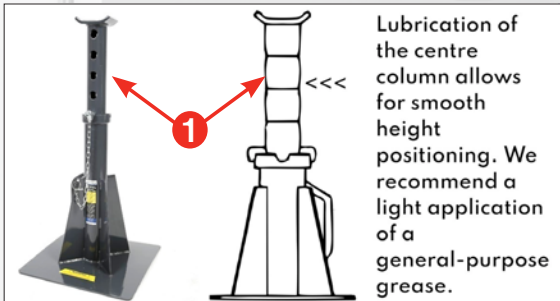

#### 2 Borum 15- and 25-ton stands come with a solid pin type locking device attached to the body with chain.

Once the correct height is reached, extend the centre column then insert the locking pin prior to lowering a vehicle onto the stand.



#### 3 Borum Pin Type Vehicle Stands must be used on a smooth horizontal surface.

Pin Type Vehicle Stands rely on a smooth flat horizontal surface to remain stable and minimise lateral forces. When raising a vehicle from an axle to place on stands the correct balanced lifting point must be used to prevent tipping or load collapse.

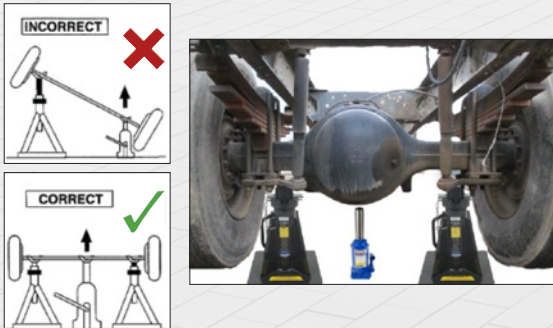

#### 4 Securing the Vehicle.

A vehicle must have the park brake applied and the wheels chocked prior to raising to place a vehicle stand. Borum Pin Type Vehicle stands can only be used to support one end of a vehicle. The stability of a vehicle on stands is critical to the safety of personnel conducting repairs.

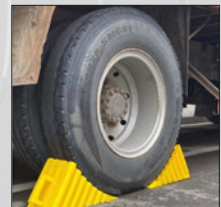
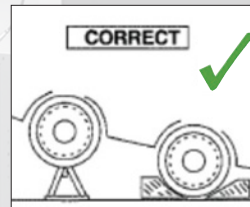

#### 5 Correct Placement.

Borum Pin Type Vehicle Stands should always have the load cradle centrally positioned on the vehicle lift points. Consult the vehicle manufacturer for lifting & vehicle stand loading points prior to elevating or supporting a vehicle.



#### 6 Garage Jacks ARE NOT substitutes for Vehicle Stands.

Jacks must be only used to raise a vehicle for the purpose of lowering on to Vehicle Stands prior to commencement of vehicle maintenance.



#### 7 Personal Safety.

No persons should be in a vehicle that is supported by Vehicle Stands. Engine must be turned off. Testing of Drivetrain or running of Engines whilst a vehicle is on stands can create vibration and potential tipping of the vehicle.

#### 8 Read the user Manual thoroughly and keep a copy easily accessible.

The user manuals are important to the initial set up and ongoing maintenance and come with each Vehicle Stand, they are also downloadable from our webpage at [www.tqbbrands.com.au](http://www.tqbbrands.com.au)

# PRODUCT INFORMATION

## How to extend the life of your Vehicle Chassis Stand

### 7 Top Tips

to extend the life of your TQB BRANDS Borum Pin Type Vehicle Chassis Stand

Includes Models: 10TSS, 10TSSSHORT

#### 1 Regularly lubricate the Centre Column.

Lubrication of the centre column on your Borum Pin Type Vehicle Chassis Stand allows for smooth height positioning. We recommend a light application of a general-purpose grease.

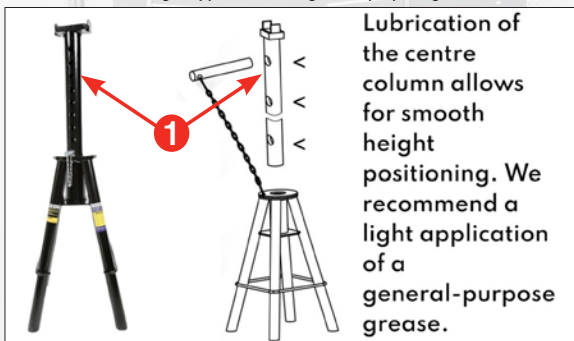

#### 2 Borum Pin Type Vehicle Chassis Stands come with a solid pin type locking device attached to the body with chain.

Once the correct height is reached, extend the centre column then insert the locking pin prior to lowering a vehicle onto the stand.

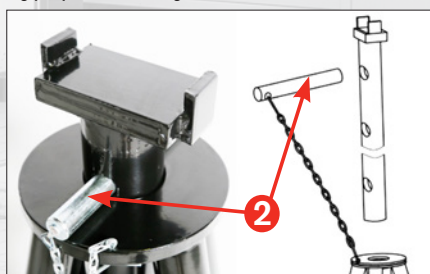

#### 3 Securing the Vehicle.

A vehicle must have the park brake applied and the wheels chocked prior to raising to place a vehicle stand. Borum Pin Type Vehicle Chassis Stands can only be used to support one end of a vehicle. The stability of a vehicle on stands is critical to the safety of personnel conducting repairs.

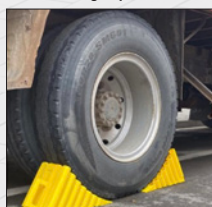
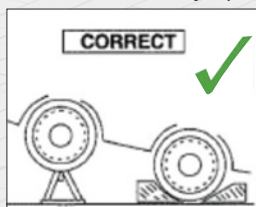

#### 4 Borum Pin Type Vehicle Chassis Stands must be used on a smooth horizontal surface.

Pin Type Vehicle Chassis Stands rely on a smooth flat horizontal surface to remain stable and minimise lateral forces. When raising a vehicle from an axle to place on stands the correct balanced lifting point must be used to prevent tipping or load collapse.

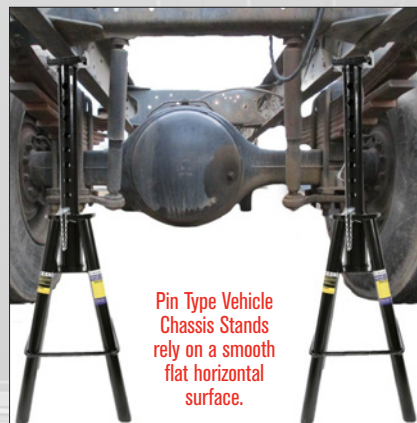

#### 5 Correct Placement.

Borum Pin Type Vehicle Chassis Stands should always have the load cradle centrally positioned on the vehicle lift points. Consult the vehicle manufacturer for lifting and vehicle stand loading points prior to elevating or supporting a vehicle.



#### 6 Personal Safety.

No persons should be in a vehicle that is supported by Vehicle Stands. Engine must be turned off. Testing of Drivetrain or running of Engines whilst a vehicle is on stands can create vibration and potential tipping of the vehicle.

#### 7 Read the user Manual thoroughly and keep a copy easily accessible.

The user manuals are important to the initial set up and ongoing maintenance and come with each Vehicle Stand, they are also downloadable from our webpage at [www.tqbbrands.com.au](http://www.tqbbrands.com.au)



# PRODUCT INFORMATION

## How to extend the life of your Borum Air Jack/Support Stand

### **8 Top Tips**

### to extend the life of your TQB BRANDS Borum Air Jack/Support Stand

**Inspections should be made before each use of the jack, checking for abnormal condition.**

**Regular inspections should be made weekly for daily use and monthly for intermittent use.**

- 1** A water trap, regulator and oiler with ISO 32 light lubricating oil must be installed at the air supply to prevent water ingress into the lift barrel and keep the system lubricated.

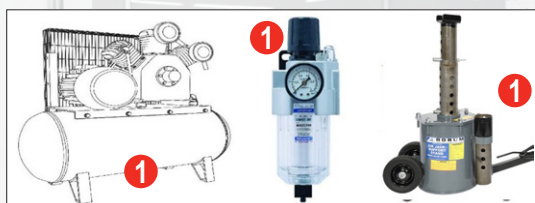

- 2** Disconnect the jack from the air hose and apply a few drops of good quality pneumatic tool oil or ISO 32 hydraulic oil through the air line weekly for daily use and monthly for intermittent use. Inspect air hose for leaks or kinks. Replace if necessary.



- 3** A periodic coating of light lubricating oil such as 30/40W Machine Oil to all lift ram shafts of the jack will help to prevent rust and assure that they move freely.



- 4** Hazards & Obstructions. All wheeled TQB Brands equipment must be used on smooth surfaces, free of cracks, crevices and tripping hazards that can foul the wheels during operation or relocation.



- 5** When the jack is not in use, Lower the saddle to its lowest position to prevent corrosion and keep the main seal in a ready to use relaxed position. Tip the Jack forward until it rests on its wheels and use an extra support block to hold the jack as shown in the illustration below. This allows trapped water to Drain from inside the cylinder.



- 6** Off centre loading or unbalanced loads can affect the smooth lowering and raising operation. Always consult your vehicle manufacturer specifications for the correct lift point. Never lift from a suspension pivot or air bag mount plate where these items are designed to travel in an arc causing excess lateral force to the jack throughout its lift cycle.



- 7** Read the users Manual thoroughly and keep a copy easily accessible.
- 8** Visit our webpage [www.tqbbrands.com.au](http://www.tqbbrands.com.au) for instructional documents & pre-start videos.



# PRODUCT INFORMATION

## How to extend the life of your Vehicle Chassis Stand

### 9 Top Tips

to extend the life of your TQB BRANDS Borum Heavy Industrial Vehicle Auxiliary Stand BAUXS7T

- 1** Regularly lubricate all spring-loaded castors and wheels for ease of movement.



- 2** Regularly lubricate the Centre Column.

Lubrication of the centre column on your Borum BAUXS7T Auxiliary Stand allows for smooth height positioning. We recommend a light application of a general-purpose grease.

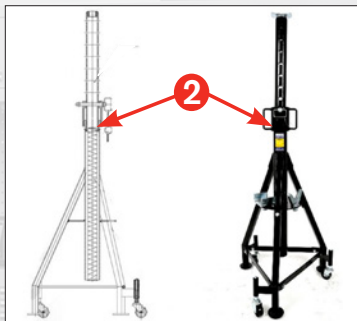

- 3** Borum BAUXS7T Auxiliary Stands come with a solid locking pin and safety latch attached to the body with a cable.

Once the correct height is reached, extend the spring-loaded centre column then insert the locking pin and safety latch prior to lowering a vehicle onto the stand or placing under a drivetrain or chassis part for support.

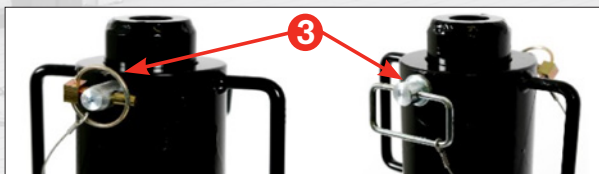

- 4** Borum BAUXS7T Auxiliary Stands must be used on a smooth horizontal surface.

Pin Type Vehicle Chassis Stands rely on a smooth flat horizontal surface to remain stable and minimise lateral forces. When raising a vehicle from an axle to place on stands the correct balanced lifting point must be used to prevent tipping or load collapse.

**WARNING:** When used to support and/or stabilise a vehicle that is raised by a 2 or 4 post hoist or In-Ground Lift, Borum BAUXS7T stands should always be used in pairs. Always use a minimum of four stands to support and stabilize a vehicle, and a minimum of two additional stands for each additional axle assembly, before commencing repairs. Consult the vehicle manufacturer for lifting and vehicle stand loading points



- 5** Securing the vehicle.

A vehicle must have the park brake applied and the wheels chocked prior to raising to place a vehicle stand. Borum Pin Type Vehicle stands can only be used to support one end of a vehicle. The stability of a vehicle on stands is critical to the safety of personnel conducting repairs.

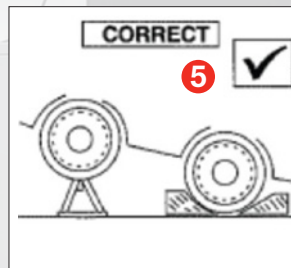

- 6** Correct Placement.

Borum BAUXS7T Auxiliary Stands come with a choice of three load adaptor heads that should always have the load cradle centrally positioned on the vehicle lift or drivetrain support points. Consult the vehicle manufacturer for lifting and vehicle stand loading points prior to elevating or supporting a vehicle or supporting suspended drivetrain parts.

- The V Head is best used to support Round Cross Beams and items such as Tail Shafts, Exhausts, Axles and provide support while other components are removed for repair.
- The Shallow sided U head is suitable for Cross Member support while removing Gearboxes and supporting Engines in situ during Drivetrain Repairs.
- The Deep sided U head is suitable for Chassis support allowing Suspension Repairs, Air Brake accessory and Fuel Tank removal.



- 7** Hazards and Obstructions.

All wheeled TQB Brands equipment must be used on smooth surface free of cracks, crevices and tripping hazards that can foul the wheels during operation or relocation.

- 8** Personal Safety.

No persons should be in a vehicle that is supported by Vehicle Stands. Engine must be turned off. Testing of Drivetrain or running of Engines whilst a vehicle is on stands can create vibration and potential tipping of the vehicle.

- 9** Read the user Manual thoroughly and keep a copy easily accessible.

The user manuals are important to the initial set up and ongoing maintenance and come with each Vehicle Stand, they are also downloadable from our webpage at [www.tqbbrands.com.au](http://www.tqbbrands.com.au)



# PRODUCT INFORMATION

## How to extend the life of your Vehicle Positioning Jacks

### 9 Top Tips

### to extend the life of your 1054T TradeQuip Vehicle Positioning Jack

- 1** Ensure all assembly bolts and fasteners are positioned correctly and tightened before use.



- 2** Regularly lubricate all castors and wheels for ease of movement once loaded.



- 3** Regularly lubricate all sides of the ratchet ladder and all components in the ratchet pawl assembly with a light spray grease to ensure smooth operation while raising and lowering the load.

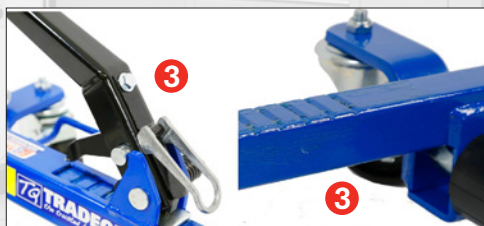

- 4** Regular cleaning of the ratchet ladder and pawl assembly is recommended where used in outdoors or in dirty environments.



We recommend using an aerosol degreaser liberally sprayed over both components then rinse and dry then reapply a spray grease [tip 3].



- 5** Ensure safe movement of your Vehicle Positioning Jack whilst under load.

To ensure safe movement of your Vehicle Positioning Jack whilst under load, always make sure the roller legs are at 90 degrees to the vehicle wheel to allow for smooth raising and reduce slippage. Roll on a smooth surface free of cracks, crevices and tripping hazards that can foul the wheels.

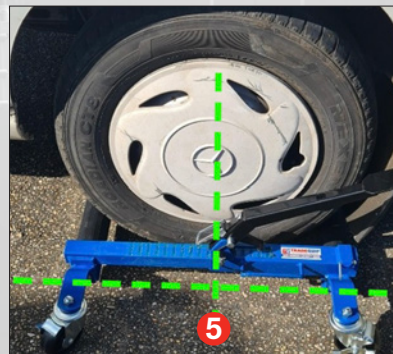

- 6** Safe Working Capacity

Tyre width, Diameter and Vehicle Gross weight are important factors to consider when using your TradeQuip Vehicle Positioning Jacks. For your safety you should not exceed the 680kg Load Rating, 280mm Maximum Tyre width and 750mm Maximum Tyre Outside Diameter.



- 7** Hazards and Obstructions.

All wheeled TQB Brands equipment must be used on smooth surface free of cracks, crevices and tripping hazards that can foul the wheels during operation or relocation.

- 8** Correct storage is vital to the longevity of your Vehicle Positioning Jacks.

Always store the Vehicle Positioning Jacks in a dry dust free area to minimise corrosion and keep the ratchet and pawl assembly clean.

- 9** Read the user Manual thoroughly and keep a copy easily accessible or visit our webpage [www.tqbbrands.com.au](http://www.tqbbrands.com.au) for instructional documents & pre-start videos.



# PRODUCT INFORMATION

## How to extend the life of your Truck Ramps

### 12 Top Tips

to extend the life of your  
TradeQuip Truck Ramp  
Models BTR20TP and BNTR20TPN



**1** Rated capacity is per pair!

Do not exceed rated capacity. Use only on hard, level surfaces capable of sustaining rated capacity loads. Use as a matched pair to support one end of a vehicle.

**2** Ramps are not to be used to simultaneously support both ends and/or one side of a vehicle.



**3** Off centre loading can cause the ramp to tilt and cause possible equipment damage and or personal injury.

Ensure the wheels of the vehicle to be mounted are centred on the ramp platform to enhance stability.



**4** Always chock or block the vehicles wheels.

Proceed slowly and cautiously when mounting a vehicle on ramps. Never accelerate or brake suddenly. Always chock or block the vehicles wheels before commencing any work.

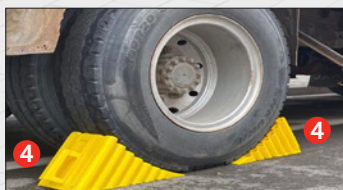

**5** Regularly lubricate wheels for ease of movement once loaded.



**6** Regularly lubricate Handle Linkage Assembly for ease of movement once loaded.



**7** Never use on a floor that has chemical spills  
Borum Truck ramps come with anti-slip nitrile base pads to prevent slippage while mounting a vehicle. To ensure long life of the anti-slip pads NEVER use on a floor that has chemical spills such as Fuels, Brake fluids, Oils, Transmission fluids or any other fluids from the Petrochemical or Glycol based family.



**8** Do not use other lifting equipment in conjunction with the ramps.

**9** Ensure other persons are clear from the vehicle path and the ramps.

**10** Do not disconnect brakes, engine, transmission components, drive train, drive shaft, universal joints, or wheels whilst the vehicle is on ramps.

**11** Hazards and Obstructions.

All wheeled TQB Brands equipment must be used on smooth surface free of cracks, crevices and tripping hazards that can foul the wheels during operation or relocation.

**12** Read the user Manual thoroughly and keep a copy easily accessible or visit our webpage [www.tqbbrands.com.au](http://www.tqbbrands.com.au) for instructional documents & pre-start videos.



# PRODUCT INFORMATION

## How to extend the life of your Vehicle Positioning Wheel Dollies

### ***10 Top Tips***

**to extend the life of your 1181T TQB BRANDS Vehicle Positioning Wheel Dollies**

- 1 Ensure all castor fasteners are positioned correctly and tightened before use.



- 2 Regularly lubricate all castors bearings and wheels for ease of movement once loaded.



- 3 For safe movement of your Vehicle Positioning Wheel Dolly whilst under load, always make sure the vehicle wheel is centred across the dolly to ensure equal load distribution across the four castors.



- 4 The 1181T Wheel Dollies each have a Platform Dimension of 400 x 300mm, for your safety you should not exceed 245mm Maximum tyre width and 750mm Maximum Tyre Outside Diameter.



- 5 **DO NOT** operate these vehicle positioning Wheel Dollies on inclined surfaces. These vehicle positioning Wheel Dollies must only be used on hard level surfaces.
- 6 **DO NOT** attempt to push vehicle positioning Wheel Dollies over obstacles. These Wheel Dollies are designed to be used on level, smooth surfaces only.
- 7 When using one pair of Dollies **SECURELY CHECK** wheels remaining on the ground until the vehicle is ready to be manoeuvred.
- 8 When using two pairs of Dollies the manoeuvring of the vehicle **MUST** be performed by a minimum of **TWO PERSONS**.
- 9 Read the users Manual thoroughly and keep a copy easily accessible.
- 10 Visit our webpage for instructional documents. @ [www.tqbbrands.com.au](http://www.tqbbrands.com.au)

# PRODUCT INFORMATION

## How to extend the life of your Truck Wheel Dolly

### 9 Top Tips

### to extend the life of your BTWD750 TQB BRANDS Vehicle Truck Wheel Dolly

- 1** Pre-Use Bleeding of the Ram assembly may be required where the unit has travelled on its side & developed air pockets within the ram assembly. Prior to mounting the ram to the frame assembly Follow this link to our downloadable Bottle Jack Document 20123456Bleeding.pdf (tqbbrands.com.au) and follow the instructions therein.

- 2** Ensure all assembly bolts and fasteners are positioned correctly and tightened before use.



- 3** Regularly lubricate all castors and wheels for ease of movement once loaded.



- 4** Regularly lubricate the rollers and pivot mechanism with a light spray grease to ensure smooth operation while raising and lowering the load.



- 5** To ensure safe movement of your Vehicle Positioning Jack whilst under load, always make sure the roller legs are at 90 degrees to the vehicle wheel to allow for smooth raising and reduce slippage.



- 6** Tyre width, Diameter and Vehicle Gross weight are important factors to consider when using your Borum Truck Wheel Dolly.

#### SAFE WORKING CAPACITY 750KG

Max Tyre Outside Diameter: 1059mm



Max Tyre Width: 660mm

For your safety you should not exceed the 750Kg Load Rating, 660mm Maximum Dual or Single Wheel/Tyre width and 1059mm Maximum Tyre Outside Diameter.

- 7** Hazards and Obstructions.

All wheeled TQB Brands equipment must be used on smooth surface free of cracks, crevices and tripping hazards that can foul the wheels during operation or relocation.

- 8** Correct storage is vital to the longevity of your Truck Wheel Dolly.

Always store the Truck Wheel Dolly in a dry dust free area to minimise corrosion and keep the all moving parts clean and lubricated.

- 9** Read the user Manual thoroughly and keep a copy easily accessible or visit our webpage [www.tqbbrands.com.au](http://www.tqbbrands.com.au) for instructional documents & pre-start videos.



# PRODUCT INFORMATION

## How to extend the life of your Parts Washer

### 9 Top Tips

to extend the life of your TQB BRANDS Parts Washers

Includes Models: 1003T & 1004T

Best suited for low-volume items, these Parts Washers are typically ideal for cleaning smaller parts, where contaminants can be removed with a brush under low pressure.

#### 1 Set up and Ventilation.

Choose a firm, flat and level surface to site the machine on, in a well ventilated area and away from any naked flames.



#### 2 Correct Cleaning Fluid.

TQB Brands recommends the use of our Tradequip 5082T & 5083T biodegradable aqueous parts washer cleaning fluid to be used at a dilution rate of five to one for best cleaning results and parts washer pump longevity.



#### 3 Incorrect Cleaning Fluid.

Petroleum or solvent based cleaning fluids and high alkaline and acidic cleaning fluids are harmful to the steel tank and protective coatings and will damage the pump and void the warranty. Consult manufacturers MSDS to ensure the fluid does not have any corrosive or flammable properties.



#### 4 Tradequip Parts Washer Concentrate will not affect rubber, plastics, glass, fully cured paintwork, and most metals.

However, we recommend you consult your vehicle manufacturer to ensure parts and components being cleaned are done so according to manufacturer's specifications.

#### 5 Cleaning fluid filter replacement.

TQB Brand Parts washers have a built-in replacement cleaning fluid filter which with regular suggested 3 monthly replacement will ensure longevity of the pump. Available as Part # 1003-5.



#### 6 Regular maintenance is essential for best results.

Cleaning fluid should be changed regularly where sludge build up will settle in the bottom of the tank. This will reduce the effective cleaning ability of the parts washer and should be changed monthly or more regularly if frequency of use is higher.



#### 7 The "Quick Close" fire safe lid mechanism.

The "Quick Close" fire safe lid mechanism with a fuse-able link ensures operator protection in case of fire and should not be removed or obstructed to ensure fast and safe operation in the event of fire. Fuse-able Link available as part number 1003FL.

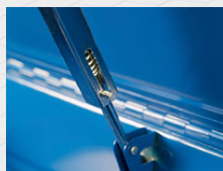

#### 8 Read the user Manual thoroughly and keep a copy easily accessible.

#### 9 Visit our webpage [www.tqbbrands.com.au](http://www.tqbbrands.com.au) for instructional & pre-start videos.



# PRODUCT INFORMATION

## How to extend the life of your Ultrasonic Parts Cleaner

### 9 Top Tips

### to extend the life of your TQB BRANDS Ultrasonic Parts Cleaner

#### 1 Electrical Safety

Prior to any maintenance make sure the unit is switched off and unplugged from the mains electricity supply socket.

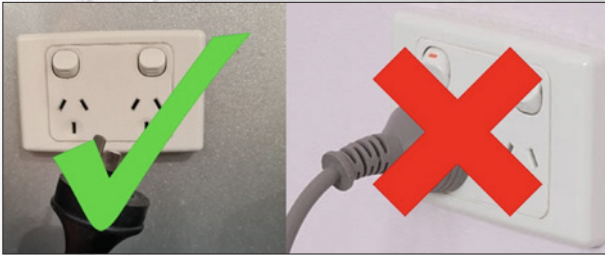

#### 2 Personal Protection and Safety

Appropriate protective PPE should be worn at all times during usage and maintenance of the TradeQuip Ultrasonic Cleaners.



#### 3 Ventilation and Noise Protection

The use of the heating function can cause cleaning solutions to create vapours. The lid must always be used, and the unit provided with adequate ventilation. This assists to reduce ultrasonic acoustic levels and cleaning solution evaporation. Please consult your cleaning solution providers MSDS for suitability when using the heating function.



#### 4 Setting Up and Ongoing Use

Do not fill over two thirds tank capacity, the parts basket must always be used, and parts must not contact the tank base.

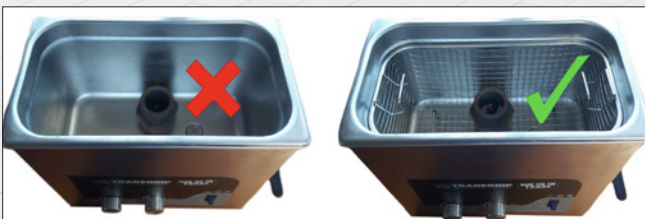

#### 5 Optimal Cleaning Settings

TQB Brands recommends the optimal temperature setting of 55 degrees when cleaning metal-based materials on the normal frequency setting. Where cleaning materials such as Nylons, Polyurethanes and other Plastics or Metallic items with non-detachable Plastic attachments we recommend a starting temperature of 20 degrees and frequency set to soft or 30 on Model 1039T. All items to be cleaned must have all oils and grease residues removed prior to cleaning in the Ultrasonic Cleaner.



#### 6 Fit for Purpose Cleaning Solutions

Ultrasonic cleaning solutions come in a variety of types suitable for different materials that need cleaning. Please consult your cleaning solution providers MSDS for the appropriate solution for your requirements. We recommend cleaning solutions used in the TQB range of Ultrasonic cleaners have an acidic/alkalinity PH range within 4 and 9 and have a zero-flash point.



**Note:** TradeQuip Parts Washer Concentrate will not affect rubber, plastics, glass, fully cured paintwork, and most metals. However, we recommend you consult your component manufacturer to ensure parts and components being cleaned are done so according to manufacturer's specifications.

#### 7 Correct and Incorrect Cleaning Fluid

TQB Brands recommends the use of our Tradequip 5082T & 5083T biodegradable aqueous parts washer cleaning fluid to be used at a dilution rate of five to one for best cleaning results and tank, heater, and transducer longevity. Petroleum or solvent based cleaning fluids and high alkaline and acidic cleaning fluids are harmful to the stainless-steel tank and protective coatings and will damage the tank and void the warranty. Consult manufacturers MSDS to ensure the fluid does not have any corrosive or flammable properties.



#### 8 Maintenance and Cleaning

TradeQuip Ultrasonic Cleaners require emptying & cleaning between uses. The Heating Element & the Transducers operate from the base of the tank. Any obstruction such as debris and sediment will affect its operation and could eventuate in premature failure.

#### 9 Read the user Manual thoroughly and keep a copy easily accessible.

The users manuals are important to the initial set up and ongoing maintenance and come with each TradeQuip Ultrasonic Cleaner, they are also downloadable from our webpage at [www.tqbbrands.com.au](http://www.tqbbrands.com.au)



# PRODUCT INFORMATION

## How to extend the life of your Engine Stand

### 9 Top Tips

### to extend the life of your TQB BRANDS Engine Stand

- 1** Ensure all assembly bolts and fasteners are positioned correctly and tightened before use.



- 2** Regularly lubricate all castors and wheels for ease of movement once loaded.



- 3** Always consult the vehicle manufacturer for correct mounting points prior to attaching an engine to your TQB Brands engine stand.



- 4** Off centre loading or unbalanced loads can affect the smooth rotating operation of engine stand.

Always mount the engine with the crank shaft below the axis of the rotating head plate to provide the safest balance point and to decrease tip over risk while rotating the engine.

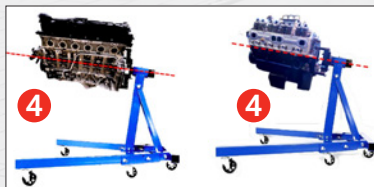

- 5** Where possible minimise the extended length of the upper two attachment adaptors to reduce possible flexing of the headstock plate.



- 6** Lock mounting plate in position before attaching the engine, and ensure the load is centred and securely mounted on the locking plate prior to releasing from the engine lift.

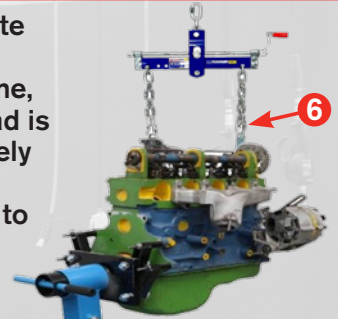

- 7** Hazards and Obstructions. All wheeled TQB Brands equipment must be used on smooth surface free of cracks, crevices and tripping hazards that can foul the wheels during operation or relocation.

- 8** Use correct model for intended applications. An engines length, width and weight should never exceed the engine stands foot print dimensions or weight specifications.

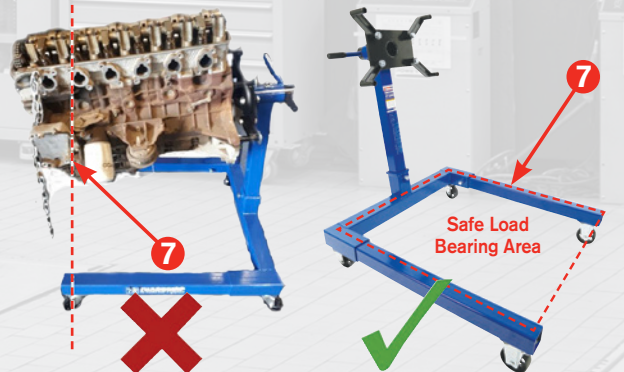

Engine Stand Model	Load Rating	Engine Type/Size/Configuration									
		Example: Up to 2lt (2lt<)	Above 2lt (2lt>)								
		Inline 4Cyl 2lt<	Inline 4Cyl 2lt>	Boxer 4Cyl 2lt<	Boxer 4Cyl 2lt>	Inline 5/6Cyl 4lt<	Inline 5/6Cyl 4lt>	V6 6 Cyl 4lt<	V6 6 Cyl 4lt>	V8 8Cyl 5lt<	V8 8Cyl 5lt>
TQES450	4500KG	Y	Y	Y	Y	N	N	N	N	N	N
1894T	5000KG	Y	Y	Y	Y	Y	Y	Y	N	N	N
1891T	6800KG	Y	Y	Y	Y	N	N	Y	Y	Y	N
1192T	9000KG	Y	Y	Y	Y	Y	Y	Y	Y	Y	Y

- 9** Read the user Manual thoroughly and keep a copy easily accessible or visit our webpage [www.tqbbrands.com.au](http://www.tqbbrands.com.au) for instructional documents & pre-start videos.



# PRODUCT INFORMATION

## How to extend the life of your Mobile Blasting Kit

### 9 Top Tips

to extend the life of your TradeQuip Mobile Blasting Kits

Includes Models: 3008 and 3032T



#### 1 Personal Safety

Media blasting generates fine dust and high velocity particles which can be harmful to your health. Correct PPE should always be worn whilst operating any Mobile Blasting Kit.

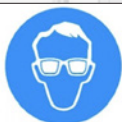

**EYE PROTECTION MUST BE WORN WHEN EQUIPMENT IS OPERATING**

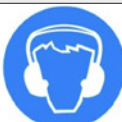

**HEARING PROTECTION MUST BE WORN IN THIS AREA**



**HAND PROTECTION MUST BE WORN IN THIS AREA**



**RESPIRATOR MUST BE WORN IN THIS AREA**

#### 2 Adequate Air pressure and Volume are two of the most important factors in a properly working TradeQuip Mobile Blasting Kits.

The Compressor Air Supply Requirement for these models ranges from: 6-25CFM (170-700LPM) @ 60 psi (413kPa) to 125 psi (860kPa) based on the 2.0 2.5 3.0 3.5mm nozzles of the 3008 and 3032T. The optimal pressure is approximately 90psi (620kPa). We recommend you start at 60 psi and gradually increase pressure, testing the blast quality until the results are satisfactory.



#### 3 Gun Angle and Distance

Direct the gun at parts at a 45-60-degree angle with ricochet away from the operator while holding the gun approximately 150mm from parts. Do not hold the gun at a 90-degree angle to parts. This will cause the media blast to bounce back into the blast stream and slow the blasting action. A 90-degree angle will cause excessive wear on the gun and potential damage to item to be cleaned. Operate the gun fully open only. Do not regulate media flow with the gun.

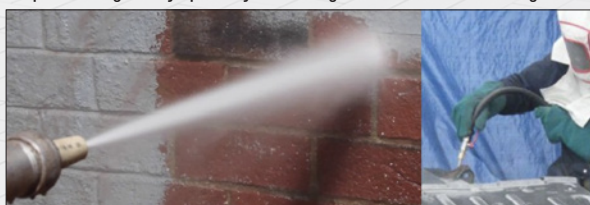

#### 4 Nozzle Size

By changing the nozzle to a larger size nozzle, production can increase significantly. Larger sized nozzles produce a larger cleaning pattern. However, this requires more air (ensure your compressor is suitable). After 10-12 hours of blasting time, the nozzle should be checked. If it shows uneven wear turn a 1/4 turn every 10 hours of use.



3008 & 3032T Nozzles

#### 5 Media

Media should be of good quality and dry. Moisture will cause the media not to flow and will clog the gun and hopper. NEVER USE SAND. There are many types and sizes of media for different finishes. Choose the correct media for the specific job.



#### 6 Media Delivery

Replace any media hose that has soft spots or visible wear. Adjust the air regulator to provide adequate flow to ensure long hose life. Where possible avoid kinking of the media/air delivery hose to avoid hose sidewall damage.

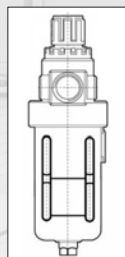

Hoses should be regularly inspected for wear, keeping your air flow and pressure regulated will prolong the hoses life.



#### 7 Caking of Media

Media caking is caused by moisture in the air supply or media storage in wet conditions. If this is not corrected media will not flow evenly and will clog up the media hose and gun. Check air supply and if water is present install a good moisture trap and always store media in a dry area away from exposure to high humidity or water ingress.

#### 8 Long Term Storage

TQB Brands recommends all media should be emptied from the blast tank prior to long term storage of the appliance to minimise media caking or solidification.

#### 9 Read the user Manual thoroughly and keep a copy easily accessible.

Visit our webpage [www.tqbbrands.com.au](http://www.tqbbrands.com.au) for instructional & pre-start videos.



# PRODUCT INFORMATION

## How to extend the life of your Mobile Blasting Kit

### 13 Top Tips

### to extend the life of your TradeQuip Model 3033T Mobile Blasting Kit

#### 1 Electrical Safety

Prior to any setting up or maintenance make sure the unit is switched off and unplugged from the mains electricity supply socket.



#### 2 Personal Safety

Media blasting generates fine dust and high velocity particles which can be harmful to your health. Correct PPE should always be worn whilst operating any Mobile Blasting Kit.



#### 3 Adequate Air pressure and Volume are two of the most important factors in a properly working TradeQuip Mobile Blasting Kits.

The Compressor Air Supply Working Volume and Pressure Requirement for this model is 15CFM (600LPM) @ 80 psi (550kPa) to 115Psi (790KPa) based on 7mm Nozzle. We recommend you install a separate separator/regulator and start at 70 psi and gradually increase pressure, testing the blast quality until the results are satisfactory.



Your TradeQuip 3033T Mobile Blasting Kit can be used with or without the Vacuum Feature.

#### 4 Gun Angle and Distance for use without Vacuum



With Vacuum collector turned off, Direct the gun at parts at a 45–60-degree angle with ricochet away from the operator while holding the gun approximately 150mm from parts. Do not hold the gun at a 90-degree angle to parts. This will cause the media blast to bounce back into the blast stream and slow the blasting action. A 90-degree angle will cause excessive wear on the gun and potential damage to item to be cleaned.

#### 5 Gun Angle and Distance for use with Vacuum

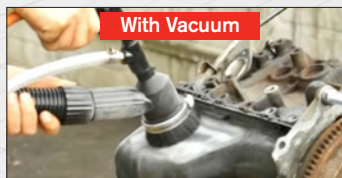

With the vacuum dust extractor turned on, hold the brush end of the Media Gun at 90 degrees and firmly against the object to be cleaned, depress the trigger move from left to right keeping notice of the blasted surface's degree of cleanliness. Slow movement will provide a cleaner surface so gauge your requirement and vary movement to suit.

#### 6 Nozzle Size

The TradeQuip 3033T Mobile Blasting Kit comes with 7mm Nozzles. After 10-12 hours of blasting time, the nozzle should be checked. If it shows uneven wear turn a ¼ turn every 10 hours of use.



Nozzle #3033T-55

#### 7 Device Care

Replace any media hose that has soft spots or visible wear. Adjust the air regulator to provide adequate flow to ensure long hose life. Where possible avoid kinking of the media/air delivery hose to avoid hose sidewall damage.

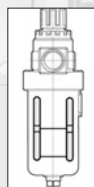

Hoses should be regularly inspected for wear, keeping your air flow and pressure regulated will prolong the hoses life.



#### 8 Media

Media should be of good quality and dry. Moisture will cause the media not to flow and will clog the gun and hopper. NEVER USE SAND. There are many types and sizes of media for different finishes. Choose the correct media for the specific job.



#### 9 Media Delivery

Your TradeQuip 3033T Blaster has a media adjustment screw installed at the base of the media tank. The screw is set at the fully wound in position, once air flow is established and media flow is still inadequate wind the screw anti clockwise 1 full turn testing for results until the cleaning degree is satisfactory.



#### 10 Caking of Media

Media caking is caused by moisture in the air supply or media storage in wet conditions. If this is not corrected media will not flow evenly and will clog up the media hose and gun. Check air supply and if water is present install a good moisture trap and always store media in a dry area away from exposure to high humidity or water ingress.

#### 11 Hazards and Obstructions.

All wheeled TQB Brands equipment must be used on smooth surface free of cracks, crevices and tripping hazards that can foul the wheels during operation or relocation.

#### 12 Long Term Storage

TQB Brands recommends all media should be emptied from the blast tank prior to long term storage of the appliance to minimise media caking or solidification.

#### 13 Read the user Manual thoroughly and keep a copy easily accessible.

Visit our webpage [www.tqbbrands.com.au](http://www.tqbbrands.com.au) for instructional documents & pre-start videos.



# PRODUCT INFORMATION

## How to extend the life of your Cabinet Media Blasters

### 9 Top Tips

to extend the life of your TradeQuip Cabinet Media Blasters

Includes Models: 3036T & 3051



#### 1 Adequate Air pressure and Volume are two of the most important factors in a properly working TradeQuip Cabinet Media Blaster.

The Compressor Air Supply Requirement for these models ranges from: 15-25CFM (425-700LPM) @ 60 psi (413kPa) to 125 psi (860kPa) based on the 5 to 6mm nozzles of the 3036T and the 4, 5, 6, and 7mm nozzles supplied with the 3051. The optimal pressure is approximately 80psi (551kPa). We recommend you start at 60 psi and gradually increase pressure, testing the blast quality until the results are satisfactory.

15-25CFM (425-700LPM) @ 60 psi (413kPa) to 125 psi (860kPa).

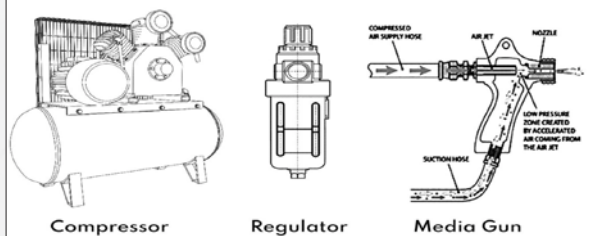

#### 2 Nozzle Size

By changing the nozzle to a larger size nozzle, production can increase significantly. Larger sized nozzles produce a larger cleaning pattern. However, this requires more air (ensure your compressor is suitable). After 10-12 hours of blasting time, the nozzle should be checked. If it shows uneven wear turn a ¼ turn every 10 hours of use



#### 3 Gun Angle and Distance

Direct the gun at parts at a 45-60-degree angle with ricochet towards the back of the cabinet while holding the gun approximately 150mm from parts. Do not hold the gun at a 90-degree angle to parts. This will cause the media blast to bounce back into the blast stream and slow the blasting action. A 90-degree angle will cause excessive wear on the gun and viewing window.



#### 4 Media

Media should be of good quality and dry. Moisture will cause the media not to flow and will clog the gun and hopper. NEVER USE SAND. There are many types and sizes of media for different finishes. Choose the correct media for the specific job.



#### 5 Media Delivery

Replace any media hose that has soft spots or visible wear. Adjust the air regulator to provide adequate flow to ensure long hose life.

Hoses should be regularly inspected for wear, keeping your air flow and pressure regulated will prolong the hoses life.

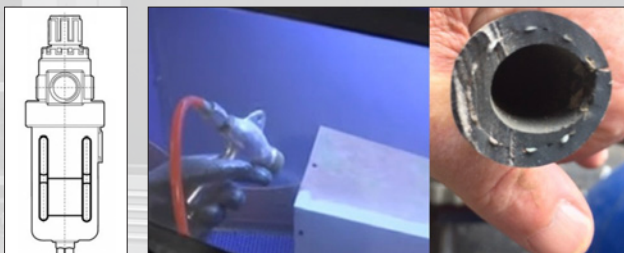

#### 6 Dust Collector

Inadequate cabinet ventilation can result in reduced cleaning power at the nozzle as well as diminished view of the work in progress. The 3051 will require a vacuum/dust collector. Use the dust collector's shaker (only on 3036T) every 20-30 minutes when the cabinet is turned off. Empty the dust collector at least once a day. Remove filter and blow out occasionally to keep the dust collector or vacuum working efficiently. Replace as needed.

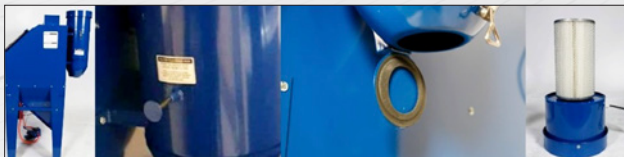

#### 7 Caking of Media

Media caking is caused by moisture in the air supply or from oily and greasy parts. If this is not corrected media will not flow evenly and will clog up the gun. Check air supply if water is present install a good moisture trap. If oily or greasy parts are being blasted, you should degrease and dry the parts prior to blasting.

#### 8 Read the user Manual thoroughly and keep a copy easily accessible.

#### 9 Visit our webpage [www.tqbbrands.com.au](http://www.tqbbrands.com.au) for instructional & pre-start videos.



# PRODUCT INFORMATION

## How to extend the life of your Porta Power Kit

### *10 Top Tips*

to extend the life of your Borum, TradeQuip and Red Label Porta Power Kit

Includes Models: BPP20T, 2010T & RL4TPP

**1 Ensure Hydraulic oil is at correct levels.**

Follow the model specific relevant owner's manual instructions for bleeding and fluid level information, also available as a download on our webpage at [www.tqbbrands.com.au](http://www.tqbbrands.com.au)



**2 Regularly lubricate Pump Linkages.**

Pump linkages come under considerable stresses so adequate lubrication of linkages will reduce wear and pumping effort when under load.



**3 Always store Rams in the fully lowered position & Pumps with the release open.**

Storage in the lowered position ensures the lift ram assembly and pump piston is sealed from exposure to weather fluctuations and keeps the hydraulic ram and pump seals in a relaxed condition ready to work when required.



**4 Porta Power Ram & Pump sets are most commonly used in body & frame repairs where a holding device is required for the repositioning & reattachment of components. A Porta Power should never be used for supporting loads.**

To ensure long life of the hydraulic lift ram seals, couplers, hoses, & pump assembly a load must not be supported by the Porta Power Ram & Pump assembly. Once a load is raised it must be supported with an appropriate supporting device.

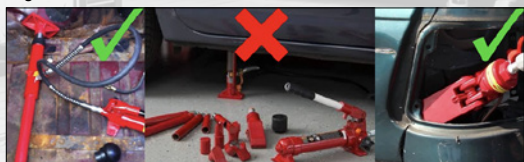

**5 TQB Brands Porta Power sets come with Offset adaptors for those difficult off-centre jobs.**

These adaptors are rated at lower pressure and must be used following the model specific manuals instructions. Model specific adaptor information can be found in your product manual or at [www.tqbbrands.com.au](http://www.tqbbrands.com.au)



**6 Use the available solid extension inserts where applicable.**

Single piston telescopic rams have their greatest stability from their fully retracted length to 85% of total extended length. Where the retracted length of the ram is shorter than distance between anchor points, the appropriate solid extension insert should always be used to close the clearance between

ram and anchor point. These extensions are rated at lower pressure and must be used by following instructions in the model specific manual and also found as a download at [www.tqbbrands.com.au](http://www.tqbbrands.com.au)

**Porta Power Accessory Load Chart**

Spreader cap. = 1/2 ton	50% of ram capacity
100% of ram capacity	100% of ram capacity
50% of ram capacity	
25% of ram capacity	
25% of ram capacity	
50% of ram capacity	
6% of ram capacity	



**7 When connecting rams or spreaders to your pump, hose couplers must always be cleaned before connection. Couplers must be tightened before applying load through the pump to prevent fluid lock and rams failing to retract.**

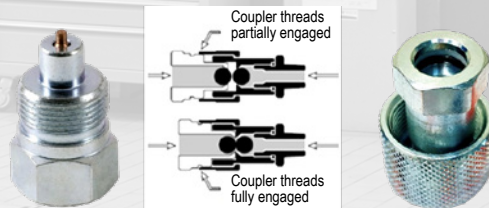

**8 Bleeding Rams can easily be performed with most compatible porta power pumps regardless of styles where push or pull ram types are employed for a job.**

With the Pump and Ram connected via the hose assembly stand the ram vertically with the inlet towards the top then follow the pumps bleed procedure instructions found on our website at [www.tqbbrands.com.au](http://www.tqbbrands.com.au)

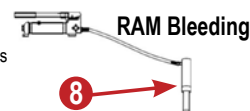

**9 TQB Brands have a selection of tonnage rated hydraulic rams suitable for general jobbing. You can find them on our website at [www.tqbbrands.com.au](http://www.tqbbrands.com.au), always use safety glasses and suitable PPE where required when operating your TQB Brands Hydraulic equipment.**

**10 Read the user Manual thoroughly & keep a copy easily accessible. Visit our webpage [www.tqbbrands.com.au](http://www.tqbbrands.com.au) for instructional documents & pre-start videos.**



# PRODUCT INFORMATION

## How to extend the life of your Air Hydraulic Pump

### 10 Top Tips

to extend the life of your TradeQuip Portable Air Hydraulic Pump

Model: 2054T

#### 1 Lubrication

Air motors require a minimum of 10 ml of a suitable lubricant such as SAE 32 Grade Hydraulic Oil or Air Tool Lubricant. Pivots should be lubricated with a 30/40W Machine Oil to ensure long life and prevent premature wear.



#### 2 Breather Cap

It is important to ensure the Brass Breather is open during pump operation and closed during storage, this prevents pump cavitation and ensures oil stays free of potential contaminants. Simply wind out 2 to 3 turns and close when not in use.

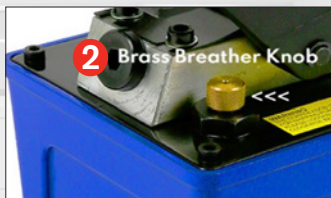

#### 3 Oil Levels

Over filling can cause damage to reservoir seals and air motor. Follow the model specific relevant owner's manual instructions for bleeding and fluid level information, also available as a download on our webpage at [2054TManual.pdf](http://2054TManual.pdf) ([tqbbrands.com.au](http://tqbbrands.com.au))

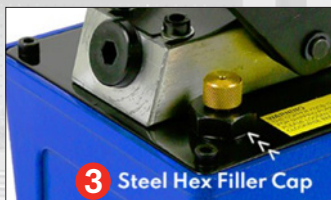

*Note: Use only TQB BRANDS approved Hydraulic SAE 32 oil. Never use brake fluid, transmission fluid, turbine oil, motor oil, alcohol, glycerine etc. Use of other than good quality hydraulic oil will void warranty and damage the pump, hose, and application.*

#### 4 Adding Hydraulic Hoses and Couplers

When installing a Hydraulic Hose or Coupler to your TradeQuip 2054T pump the reservoir volume is reduced by the oil needed to fill the hose or coupler. To re-gain the maximum useable volume, follow the step 6.2 outlined in the Owner's Manual or found here [2054TManual.pdf](http://2054TManual.pdf) ([tqbbrands.com.au](http://tqbbrands.com.au)).



#### 5 Pump Oil Capacity – Attachment Oil Capacity

Always ensure that the attached tool has lower operating oil capacity than the pumps useable oil level. Never attach an already extended ram to a full pump as excess returning oil will over fill the reservoir and damage the pump seals and air motor and void warranty.



#### 6 Hose Safety

Never handle pressurized hoses, escaping oil under high pressure can penetrate the skin, causing serious injury. Seek medical aid immediately if injured.



#### 7 Coupler Safety

Observe the following when using couplers. Make sure couplers are clean before making any connections, use dust caps to keep couplers clean. If a dust cap is not used, clean the coupler by carefully blowing the dirt out with compressed air. Tighten couplers hand tight only, do not use wrenches. Threads must be fully engaged to allow for proper two directional oil flow.



#### 8 TradeQuip 2054T Pumps combined with compatible rams are most commonly used in body and frame repairs where a holding device is required for the repositioning and reattachment of components.



*A Pump should never be used for supporting loads in combination with a ram without additional load support such as stands but can be used with clamping, holding, bead breaking and crimping devices as per device manufacturers specifications.*

#### 9 Read the user Manual thoroughly and keep a copy easily accessible.

Manuals are important to the initial set up and ongoing maintenance. They are also downloadable from our webpage at [www.tqbbrands.com.au](http://www.tqbbrands.com.au)

#### 10 Visit our webpage for instructional Videos.

We have created instructional documents and pre-start videos. You'll find these at [www.tqbbrands.com.au](http://www.tqbbrands.com.au)



# PRODUCT SUPPORT

## TQB Press Best Practice for Press Use

### TQB Brands Press Best Practice for bushing removal for Torque Rod, Control Arm and Other associated suspension bushings.

#### APPLIES TO ALL TQB BRANDS SHOP PRESSES

Supplied press blocks are designed to work to the peak capacity of the ram but only when sufficient care is taken to spread the load across the press blocks surface where maximum strength is calculated.

That being load radiating outwards from the centre of the block or combined blocks.

The photo supplied shows the bush housing resting on the edges of both blocks which when force is applied limits the effective spread of load to a very limited contact point.



Should this style of mounting be miscalculated and limit the effective contact area, the block or blocks will deform.

Where a miscalculation of the positioning of the housing occurs the bush itself may easily come into contact with the block during pushing operation.

This would effectively cause the ram to be forcing off set load directly to the edge or edges of one or both blocks. Given that the load is not spread ideally across the full surface, bending of the block/blocks would be expected as seen in the photos supplied.

We suggest best practice for this operation would include a device or devices such as a universal push pull sleeve set.

Full support of the bush housing can then be applied across the centre of the block/blocks using an outside diameter matched sleeve as support for the housing and an inside diameter matched sleeve as the pushing adaptor to push the bush out of the housing.

The cavity created below the bush housing by the sleeve allows for space for the bush to push through into it. This will prevent the bush from contacting the block surface stalling its movement and causing direct off set forces and possible breakage, damage or injury.



FOR BEST & SAFEST BUSHING REMOVAL USE AN OUTSIDE DIAMETER SUPPORT SLEEVE, AN INSIDE DIAMETER PUSH SLEEVE & A PUSH SLEEVE ADAPTOR TO PRESS AGAINST.

Always ensure all adaptors and sleeves are rated to the job at hand and are correctly used as per owners manuals. Use all guard protection devices and eye protection where provided in all pressing applications.



# PRODUCT INFORMATION

## How to extend the life of your Manual Press

### Top Tips

### CRITICAL INFORMATION for your TQB Brands Borum and TradeQuip Manual Press

This document covers the following models. 1061T, 1062T, 1063T, 1064T, BHSP20T, BHSP30T.

#### SETTING UP AND OPERATIONAL AND PREVENTATIVE MEASURES

- Ensure that the press is situated on a flat level surface with base frame feet in full contact with the floor.



- Once the press is positioned, we recommend using suitable fasteners to attach the press feet to your flat floor to prevent movement of the press during all operational procedures.

#### Hydraulic Safety Measures.

- Never touch or handle a pressurised hydraulic hose or pressurised hydraulic coupler. These must always be securely tightened & fastened before pressurising.

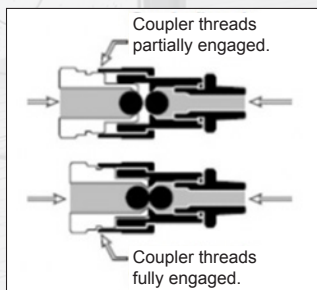

- Never exceed the maximum hydraulic pressure range as defined by the rated capacity label and the red line or coloured warning section on the applicable press gauge.



**Note:** Where no gauge is present the Tradequip bottle jack presses are governed by a safety valve to prevent over pressure.

- Where sufficient force cannot be developed to complete a pressing job requiring a higher capacity than the press output, do not force the ram by over pressurising the pump pedal or hand piece.
- Always raise the press bed so the workpiece is as close to the fully retracted ram load cap as possible to minimise overstroke.



- Always ensure that all compatible pushing adaptors supplied for the press ram have been correctly attached to the ram output shaft to provide lateral stability and prevent damage to the ram.



- Where supplied or available as an accessory you should always use a safety cage during pressing operations.
- Keep your press bed and bed blocks clean to ensure firm job contact between Bed, Bed Blocks and Ram Load Cap.
- When not in use keep your press ram fully retracted to prevent corrosion and contamination ingress.





# PRODUCT INFORMATION

## How to extend the life of your Air Manual Press

### Top Tips

### CRITICAL INFORMATION for your TQB Brands Borum & TradeQuip Air Manual Press

This document covers the following models. 2038T, 2048T, BSP100TA, BSP75TA, PROSHPR30TA & PROSHPR50TA.

#### SETTING UP AND OPERATIONAL AND PREVENTATIVE MEASURES

- Ensure that the press is situated on a flat level surface with base frame feet in full contact with the floor.

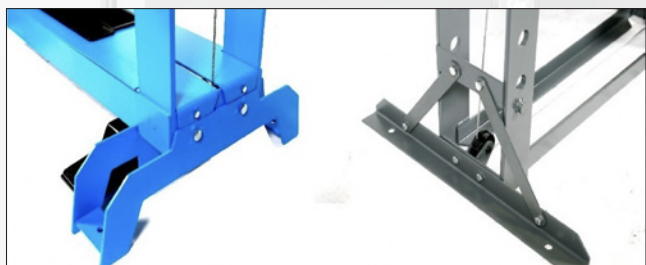

- Once the press is positioned, we recommend using suitable fasteners to attach the press feet to your flat floor to prevent movement of the press during all operational procedures.

#### Hydraulic Safety Measures.

- Never touch or handle a pressurised hydraulic hose or pressurised hydraulic coupler. These must always be securely tightened & fastened before pressurising.

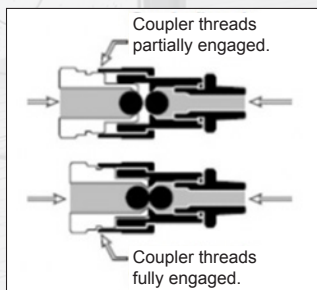

- Never exceed the maximum hydraulic pressure range as defined by the rated capacity label and the red line or coloured warning section on the applicable press gauge.



**Note:** Where no gauge is present the Tradequip bottle jack presses are governed by a safety valve to prevent over pressure.

- Air supply must be regulated to a maximum of 100Psi/690kPa to prevent premature wear in the air/hydraulic pump.
- A water trap must be installed at the air supply to prevent water ingress into the air/hydraulic pump.

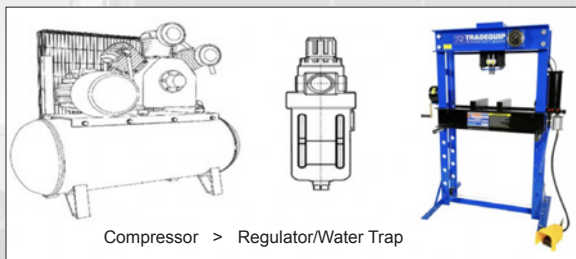

- Where sufficient force cannot be developed to complete a pressing job requiring a higher capacity than the press output, do not force the ram by over pressurising the hand piece or extended holding open the foot pedal air supply.
- With the ram fully retracted always raise the workpiece as close to the ram as possible to minimise overstroke and achieve maximum stability at minimum clearance.



- Always ensure that all compatible pushing adaptors supplied for the press ram have been correctly attached to the ram output shaft to provide lateral stability and prevent damage to the ram.

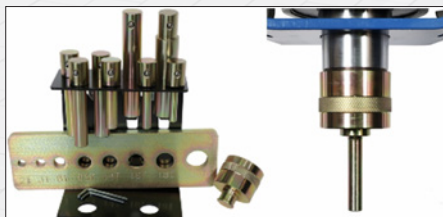



# PRODUCT INFORMATION

## How to extend the life of your Air Manual Press

### Top Tips

### CRITICAL INFORMATION for your TQB Brands Borum & TradeQuip Air Manual Press

This document covers the following models. 2038T, 2048T, BSP100TA, BSP75TA, PROSHPR30TA & PROSHPR50TA.

#### USE A SAFETY GUARD DURING PRESSING OPERATIONS

- Where supplied or available as an accessory you should always use a safety cage during pressing operations.

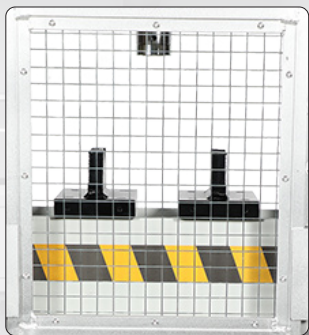

- Keep your press bed and bed blocks clean to ensure firm job contact between Bed, Bed Blocks and Ram Load Cap.
- When not in use keep your press ram fully retracted to prevent corrosion and contamination ingress.



#### SAFETY GUARDS NOW AVAILABLE THROUGH TQB BRANDS

#### Polycarbonate TQB Shop Press Safety Barrier



SUIT TQB BRANDS PRESSES ONLY

MADE FOR THE TRADE

**SGUARD-1**  
PRESS GUARD  
POLY CARBONATE  
SUIT 1061/1062/1063T

Multiple Height Settings

**SGUARD-3**  
PRESS GUARD  
POLY CARBONATE  
SUIT BSP75TA

**SGUARD-2**  
PRESS GUARD  
POLY CARBONATE  
SUIT 1064T

**SGUARD-4**  
PRESS GUARD  
POLY CARBONATE  
SUIT 2048T/2038T/  
2036T/BSP100TA

\*\* AVAILABLE IN FOUR DIFFERENT SIZES \*\*





# PRODUCT INFORMATION

## How to extend the life of your WorkshopMate Workstation

### Top Tips

### CRITICAL INFORMATION for your TQB Brands WSM4 WorkshopMate Workstation

#### SETTING UP AND OPERATIONAL AND PREVENTATIVE MEASURES

- Ensure that the press is situated on a flat level surface with all 4 wheels in contact with the floor.



- When positioning the press, never roll over cracks/crevices/leads/air lines to ensure the press remains upright during relocation in your workshop and to prevent damage to the castors and also to prevent tip over.
- Once the press is positioned engage the castor wheel locks to prevent movement of the press during all operational procedures.



- Air supply must be regulated to a maximum of 100Psi/690kPa to prevent premature wear in the air/hydraulic pump.
- A water trap must be installed at the air supply to prevent water ingress into the air/hydraulic pump.

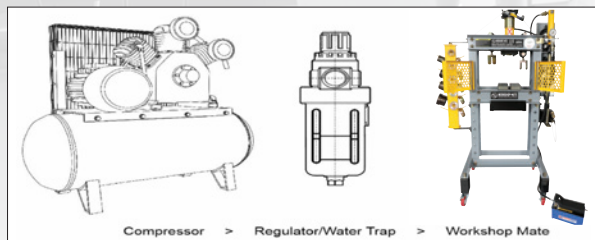

#### Hydraulic Safety Measures.

- Never touch or handle a pressurised hydraulic hose or pressurised hydraulic coupler.
- Never exceed the maximum hydraulic pressure range of 8700Psi/600Bar/60MPa.



- When using the ram selector tap for switching the hydraulic oil supply between the 30-ton press ram and the spring compressor ensure both rams have been fully retracted first.
- Never switch oil supply between hydraulic rams if the hydraulic circuit is pressurised.
- Never extend the ram more than necessary.
- Do not force the ram by holding the foot pump down for an extended period.
- Always raise the workpiece as close to the ram as possible to minimise overstroke.





# PRODUCT INFORMATION

## How to extend the life of your WorkshopMate Workstation

### Operational Safety for Hub Press/Oil Filter Crusher.

- Always ensure that all pushing adaptors supplied for the 30-ton press ram have been fully screwed into the ram output shaft to provide lateral stability and prevent damage to the ram output shafts internal threads.



- We recommended keeping a pair of vernier callipers on hand to measure bearing races and bushing diameters to enable correct fit selection of the tooling for removal applications.



- When using the adaptor sleeves always choose combinations that interlock to provide stability during bearing/hub replacements.
- Always close the safety cage doors during pressing operations.
- Do not make changes to any adaptors/tooling provided.
- Only suited for most passenger and light commercial vehicles.



### Operational Safety for Spring Compressor.

- Suspension coil springs have considerably different lengths between compressed and decompressed during their removal from strut assemblies. We recommend extending the coil spring removal ram to 100mm to 150mm prior to attaching the coil grab adaptors to compensate for this decompression and prevent leaving the spring under load when the ram is fully retracted.



- Use only adaptors & attachments supplied with your WorkshopMate Workstation spring compressor.
- Always measure the spring outer diameter when choosing to use the coil adaptors, do not exceed the adaptors diameter capacity.
- Always measure the spring's coil diameter when choosing to use the coil grab adaptors, do not exceed the grab adaptors diameter capacity.
- Always use the supplied cable strut/spring restraints when compressing springs.
- Only suited for most passenger and light commercial vehicles



### Read the user Manual thoroughly and keep a copy easily accessible.

The users manuals are important to the initial set up and ongoing maintenance and come with the WorkshopMate Workstation, they are also downloadable from our webpage at.....

[www.tqbbrands.com.au](http://www.tqbbrands.com.au)



# PRODUCT INFORMATION

## How to extend the life of your Hydraulic Press

### 8 Top Tips

to extend the life of your **TQB BRANDS TradeQuip Hydraulic Press**

Includes Models: 1002, 1060T, 1186T, 1061T & 1062T

#### 1 Ensure Hydraulic oil is at correct levels.



Follow the TradeQuip series relevant owners manual bleeding instructions for fluid levels, also available as a download on our webpage at [www.tqbbrands.com.au](http://www.tqbbrands.com.au)

#### 4 Always store the press ram in the fully retracted position.

Storage in the retracted position ensures the TradeQuip press ram assembly is sealed from exposure to weather fluctuations and keeps the hydraulic ram and pump seals in a relaxed condition ready to work when required.



#### 2 Lubrication Points.

Keeping your press frame and ram assemblies lubricated is essential to providing ease of operation. Follow TradeQuip series relevant owners manual for lubrication instructions, also available as a download on our webpage at [www.tqbbrands.com](http://www.tqbbrands.com).



#### 5 Press Block use.

TradeQuip presses come with specialty load rated press blocks that should always be used in all pressing applications where maximum ram capacity can be reached. DO NOT substitute press blocks with any other items.



#### 3 Job/Bed positioning and ram stroke are critical factors when performing pressing jobs.

Single piston telescopic TradeQuip Press Rams have their greatest stability from the fully retracted position to 85% of total extended position. When pressing you should always use the bed to raise the job to the ram then secure with the bed pins. The wind out screw extension where provided should always be used to close the clearance between ram and jobs load point, this greatly reduces the potential of lateral force and accidental ram overstroke.

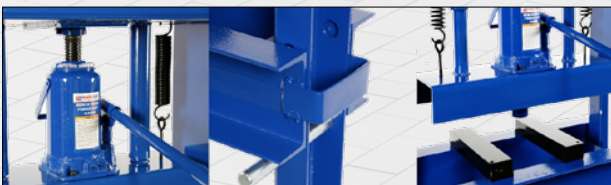

#### 6 TQB Brands have a selection of force rated press tools suitable for general jobbing.

You can find them on our website at [www.tqbbrands.com](http://www.tqbbrands.com). Always use safety glasses and suitable PPE where required when operating your TQB Brands Press.



#### 7 Read the users Manual thoroughly and keep a copy easily accessible.

#### 8 Visit our webpage [www.tqbbrands.com.au](http://www.tqbbrands.com.au) for instructional documents & pre-start videos.



# PRODUCT INFORMATION

## How to extend the life of your Air/Hydraulic Press

### *10 Top Tips*

to extend the life of your TQB BRANDS Borum & Tradequip Air/Hydraulic Press

Includes Models: BHSP20T, BHSP30T, 1187T

#### 1 Ensure Hydraulic oil is at correct levels.

Follow the BHSP series and 1187T relevant owner's manual bleeding instructions for fluid levels, also available as a download on our webpage at [www.tqbbrands.com.au](http://www.tqbbrands.com.au)



Remove the pump assembly cover and slide off over the control knobs to reveal the filler cap.



#### 2 Lubrication points.

Keeping your Press frame, pivots and sliding ram assemblies lubricated is essential to providing ease of operation, follow the BSP and PROSHPR series relevant owner's manual for lubrication instructions, also available as a download on our webpage at [www.tqbbrands.com.au](http://www.tqbbrands.com.au)



#### 3 Always store the press ram in the fully retracted position.

Storage in the retracted position ensures the press ram assembly is sealed from exposure to weather fluctuations & keeps the hydraulic ram & pump seals in a relaxed condition ready to work when required.



#### 4 Bed positioning.

To raise bed height, remove the bed pins then use the winch provided to raise the bed to the ideal height then insert the bed pins to secure the bed then loosen winch cable by winding the winch back 1 full turn to prevent the cable being stretched under load.



#### 5 Offset ram positioning.

Where offset pressing jobs are required position the job on the bed at the most convenient position and slide the ram across the headstock and centre the ram load cap over the job then use the locking screw to secure the ram in position.



#### 6 Job positioning and ram stroke are critical factors when performing pressing jobs.

Single piston telescopic Press Rams have their greatest stability from the fully retracted position to 85% of total extended position. When pressing you should always use the bed to raise the job to the ram then secure with the bed pins. Solid extension inserts should always be used to close the clearance between ram and jobs load point, this greatly reduces the potential of lateral force and accidental ram overstroke. Solid extension kit available through your TQB Brands distributor or check out our where to buy page at [www.tqbbrands.com.au](http://www.tqbbrands.com.au)



#### 7 Press block use.

The Borum and Tradequip presses come with specialty load rated press blocks that should always be used in all pressing applications where maximum ram capacity can be reached. DO NOT substitute press blocks with any other items.



#### 8 TQB Brands have a selection of force rated press tools suitable for general jobbing.

You can find them on our website at [www.tqbbrands.com.au](http://www.tqbbrands.com.au) Always use safety glasses and suitable PPE where required when operating your TQB Brands Press.



#### 9 Read the user Manual thoroughly and keep a copy easily accessible.

#### 10 Visit our webpage [www.tqbbrands.com.au](http://www.tqbbrands.com.au) for instructional documents & pre-start videos.



# PRODUCT INFORMATION

## How to extend the life of your Air/Hydraulic Press

### *10 Top Tips*

to extend the life of your **TQB BRANDS** Borum and TQPro Air/Hydraulic Press

Includes Models: PROSHPR30TA, PROSHPR50TA, BSP75TA

- 1** Ensure Hydraulic oil is at correct levels. Follow the BSP and PROSHPR series relevant owner's manual bleeding instructions for fluid levels, also available as a download on our webpage at [www.tqbbrands.com.au](http://www.tqbbrands.com.au)

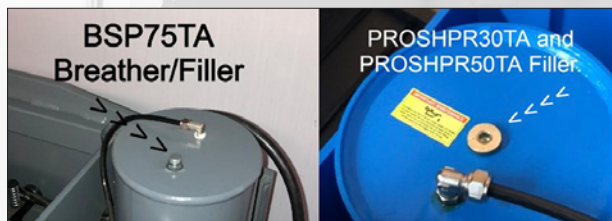

- 2** Lubrication points. Keeping your Press frame, pivots and sliding ram assemblies lubricated is essential to providing ease of operation, follow the BSP and PROSHPR series relevant owner's manual for lubrication instructions, also available as a download on our webpage at [www.tqbbrands.com.au](http://www.tqbbrands.com.au)



- 3** Always store the press ram in the fully retracted position. Storage in the retracted position ensures the press ram assembly is sealed from exposure to weather fluctuations & keeps the hydraulic ram & pump seals in a relaxed condition ready to work when required.



- 4** Bed positioning. To raise bed height, remove the bed pins then use the winch provided to raise the bed to the ideal height then insert the bed pins to secure the bed then loosen winch cable by winding the winch back 1 full turn to prevent the cable being stretched under load.



- 5** Offset ram positioning. Where offset pressing jobs are required position the job on the bed at the most convenient position and slide the ram across the headstock and centre the ram load cap over the job then use the locking screw to secure the ram in position.

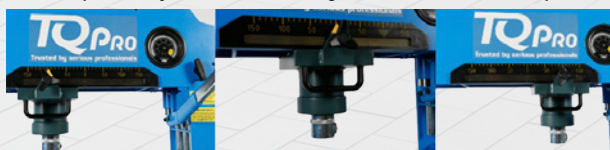

- 6** Job positioning and ram stroke are critical factors when performing pressing jobs. Single piston telescopic Press Rams have their greatest stability from the fully retracted position to 85% of total extended position. When pressing you should always use the bed to raise the job to the ram then secure with the bed pins. The wind out screw extension or solid extension inserts should always be used to close the clearance between ram and jobs load point, this greatly reduces the potential of lateral force and accidental ram overstroke.

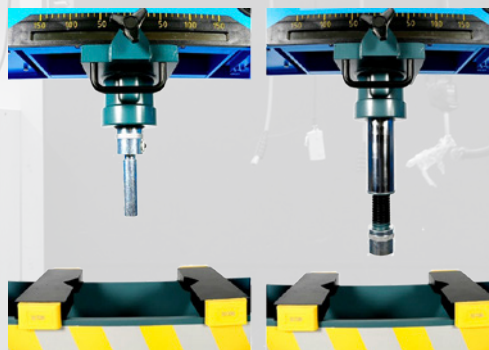

- 7** Press block use. The Borum and TQPro presses come with specialty load rated press blocks that should always be used in all pressing applications where maximum ram capacity can be reached. DO NOT substitute press blocks with any other items.



- 8** TQB Brands have a selection of force rated press tools suitable for general jobbing. You can find them on our website at [www.tqbbrands.com.au](http://www.tqbbrands.com.au) Always use safety glasses and suitable PPE where required when operating your TQB Brands Press.



- 9** Read the user Manual thoroughly and keep a copy easily accessible.  
**10** Visit our webpage [www.tqbbrands.com.au](http://www.tqbbrands.com.au) for instructional documents & pre-start videos.



# PRODUCT INFORMATION

## How to extend the life of your TradeQuip Hydraulic Press

### *10 Top Tips*

to extend the life of your **TQB BRANDS TradeQuip Hydraulic Press**

Includes Models: 1063T and 1064T

#### 1 Ensure Hydraulic oil is at correct levels.

Follow the 1060 series relevant owners manual bleeding instructions for fluid levels, also available as a download on our webpage at [www.tqbbrands.com.au](http://www.tqbbrands.com.au)

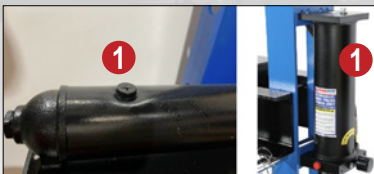

#### 2 Lubrication points.

Keeping your Press frame, pivots and sliding ram assemblies lubricated is essential to providing ease of operation, follow the 1060 series relevant owners manual for lubrication instructions, also available as a download on our webpage at [www.tqbbrands.com.au](http://www.tqbbrands.com.au)

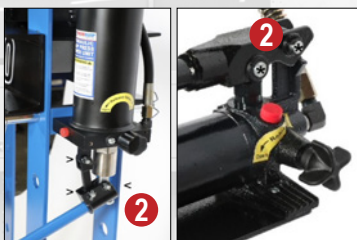

Lubricate these pivots with a Light Grade general purpose Bearing Grease

#### 3 Always store the press ram in the fully retracted position.

Storage in the retracted position ensures the press ram assembly is sealed from exposure to weather fluctuations and keeps the hydraulic ram and pump seals in a relaxed condition ready to work when required.



#### 4 Job positioning and ram stroke are critical factors when performing pressing jobs.

Single piston telescopic Press Rams have their greatest stability from the fully retracted position to 85% of total extended position. When pressing you should always use the bed to raise the job to the ram then secure with the bed pins. Solid extension inserts should always be used to close the clearance between ram and jobs load point, this greatly reduces the potential of lateral force and accidental ram overstroke. Solid extension kit available through your TQB Brands distributor or check out our where to buy page at [www.tqbbrands.com.au](http://www.tqbbrands.com.au)



#### 5 Bed positioning.

To raise the bed height, remove all accessories from the bed and support the bed before removing the bed pins one side at a time repositioning the pins either up or down depending on the job requirements.

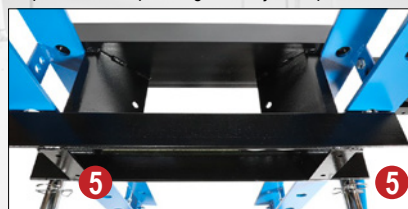

#### 6 Offset Ram Positioning.

Where offset pressing jobs are required position the job on the bed at the most convenient position and slide the ram across the headstock and centre the ram load cap over the job then use the locking screw where available to secure the ram in position.

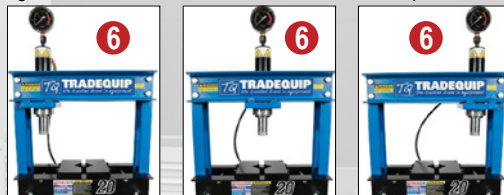

#### 7 Press block use.

TradeQuip presses come with specialty load rated press blocks that should always be used in all pressing applications where maximum ram capacity can be reached. DO NOT substitute press blocks with any other items.



#### 8 TQB Brands have a selection of force rated press tools suitable for general jobbing.

You can find them on our website at [www.tqbbrands.com.au](http://www.tqbbrands.com.au) Always use safety glasses and suitable PPE where required when operating your TQB Brands Press.



#### 9 Read the users Manual thoroughly and keep a copy easily accessible.

#### 10 Visit our webpage [www.tqbbrands.com.au](http://www.tqbbrands.com.au) for instructional documents & pre-start videos.



# PRODUCT INFORMATION

## How to extend the life of your Manual & Air/Hydraulic Press

### 9 Top Tips

to extend the life of your  
**TQB BRANDS Manual  
and  
Air/Hydraulic Press**

Includes Models:  
2036T  
2038T and  
2048T

#### 1 Ensure Hydraulic oil is at correct levels.

Follow the 2036T/2038T/2048T relevant owners manual bleeding instructions for fluid levels, also available as a download on our webpage at [www.tqbbrands.com.au](http://www.tqbbrands.com.au)

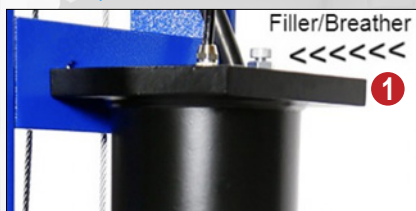

#### 2 Lubrication points.

Keeping your Press frame, pivots and bed raising assemblies lubricated is essential to providing ease of operation. Follow the relevant TradeQuip owners manual for lubrication instructions, also available as a download on our webpage at [www.tqbbrands.com.au](http://www.tqbbrands.com.au)



#### 3 Always store the press ram in the fully retracted position.

Storage in the retracted position ensures the press ram assembly is sealed from exposure to weather fluctuations and keeps the hydraulic ram and pump seals in a relaxed condition ready to work when required.



#### 4 Bed positioning.

To raise the bed height, remove the bed pins then use the winch provided to raise the bed to the ideal height then insert the bed pins to secure the bed then loosen the winch cable by winding the winch back 1 full turn to prevent the cable being stretched under load.

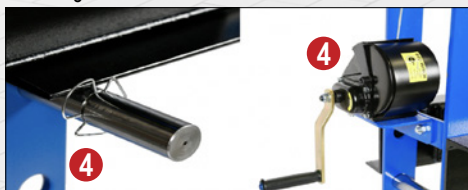

#### 5 Job positioning and ram stroke are critical factors when performing pressing jobs.

Single piston telescopic Press Rams have their greatest stability from the fully retracted position to 85% of total extended position. When pressing you should always use the bed to raise the job to the ram then secure with the bed pins. Solid extension inserts should always be used to close the clearance between ram and jobs load point, this greatly reduces the potential of lateral force and accidental ram overstroke.

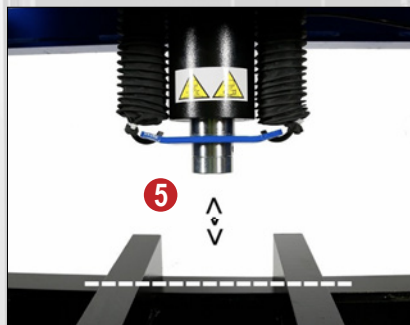

#### 6 Press block use.

TradeQuip presses come with specialty load rated press blocks that should always be used in all pressing applications where maximum ram capacity can be reached. DO NOT substitute press blocks with any other items.

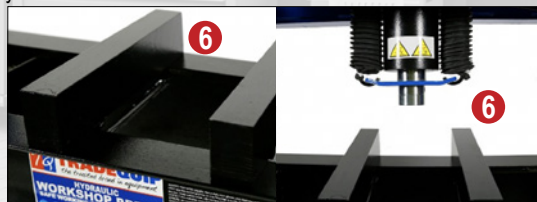

#### 7 TQB Brands have a selection of force rated press tools suitable for general jobbing.

You can find them on our website at [www.tqbbrands.com.au](http://www.tqbbrands.com.au) Always use safety glasses and suitable PPE where required when operating your TQB Brands Press.



#### 8 Read the users Manual thoroughly and keep a copy easily accessible.

#### 9 Visit our webpage [www.tqbbrands.com.au](http://www.tqbbrands.com.au) for instructional documents & pre-start videos.



# PRODUCT INFORMATION

## How to extend the life of your 100T Hydraulic Press

### 9 Top Tips

to extend the life of your TQB BRANDS Borum BSP100TA Hydraulic Press

#### 1 Ensure Hydraulic oil is at correct levels.

Follow the BSP series relevant owner's manual bleeding instructions for fluid levels, also available as a download on our webpage at [www.tqbbrands.com.au](http://www.tqbbrands.com.au)



#### 2 Lubrication points.

Keeping your Press frame, pivots and sliding ram assemblies lubricated is essential to providing ease of operation, follow the BSP series relevant owner's manual for lubrication instructions, also available as a download on our webpage at [www.tqbbrands.com.au](http://www.tqbbrands.com.au)



#### 3 Always store the press ram in the fully retracted position.

Storage in the retracted position ensures the press ram assembly is sealed from exposure to weather fluctuations & keeps the hydraulic ram & pump seals in a relaxed condition ready to work when required.



#### 4 Bed positioning.

To raise bed height, remove the bed pins then use the winch provided to raise the bed to the ideal height then insert the bed pins to secure the bed then loosen winch cable by winding the winch back 1 full turn to prevent the cable being stretched under load.



#### 5 Job positioning and ram stroke are critical factors when performing pressing jobs.

Single piston telescopic Press Rams have their greatest stability from the fully retracted position to 85% of total extended position. When pressing you should always use the bed to raise the job to the ram then secure with the bed pins to close the clearance between ram and jobs load point, this greatly reduces the potential of lateral force and accidental ram overstroke.



#### 6 Offset ram positioning.

Where offset pressing jobs are required position the job on the bed at the most convenient position and use the crank handle in the ram slewing mechanism to move the ram across the headstock to centre the ram load cap over the job.

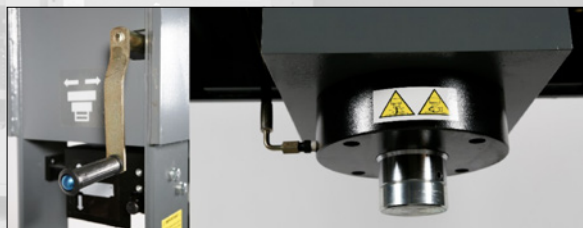

#### 7 Press block use.

The Borum presses come with specialty load rated press blocks that should always be used in all pressing applications where maximum ram capacity can be reached. DO NOT substitute press blocks with any other items.



#### 8 Read the user Manual thoroughly and keep a copy easily accessible.

#### 9 Visit our webpage [www.tqbbrands.com.au](http://www.tqbbrands.com.au) for instructional documents & pre-start videos.



# PRODUCT INFORMATION

## How to extend the life of your Air/Hydraulic Motorcycle Lift

### *ii Top Tips*

### to extend the life of your TradeQuip Air/Hydraulic Motorcycle Lift Model 2103T

#### 1 Personal Safety

Correct PPE should always be worn whilst operating any Motorcycle Lift.



#### 2 Setting Up and Leveling the Lift

To ensure safe operation your TradeQuip Motorcycle Lift must be used on a flat level surface. The 2103T model has leveling adjusters that should be used in conjunction with a spirit level to achieve a safe level lift platform.



#### 3 Ensure Hydraulic Oil is at correct levels

Disconnect the air supply and stand the Air Hydraulic pump vertically on its end and remove the filler/breather then fill to the bottom of the filler hole with SAE32 grade Hydraulic oil. Re-attach the air supply then place the pump back on the floor and extend the lift to fully raised then lower to fully lowered and recheck the level again refilling if required.



#### 4 Regularly Lubricate the Air Motor

Lubrication of the air motor is essential for smooth operation while raising a vehicle.



#### 5 Frame Pivots and Rollers Lubrication

Pivots, Pins and Rollers should be lubricated with a Light Bearing Grease or 30/40W Machine Oil to ensure long life, smooth operation and prevent premature wear.



#### 6 Safety Locking Device Care

Your TradeQuip 2103T Motorcycle Lift comes with a Safety Device consisting of a ratchet ladder and pawl system. This Safety Devices hinge points and ratchet ladder must be kept lubricated and clear of any debris to ensure safe engagement during load raising and holding.



#### 7 Mounting Your Motorcycle

Do not use the leading plate to support the weight of the motorcycle when lifting. The leading plate is only used to assist with wheeling the motorcycle onto the platform when the lift is as its lowest level. Align the front or rear wheel within the wheel clamp Jaws and close the Jaws until the motorcycle is held firmly in a vertical position. Use adjustable load rated load restraint straps to secure the motorcycle to the platform.



#### 8 Adding the ATV Accessory Ramps

The Model 2103T motorcycle Lift can be used to lift ATV's by purchasing the separately sold 2103T-EXT width extender panels. With a combined width of 1218mm this extension provides a stable platform for use with small to mid-sized ATV's. Use adjustable load rated load restraint straps to secure the ATV to the platform.

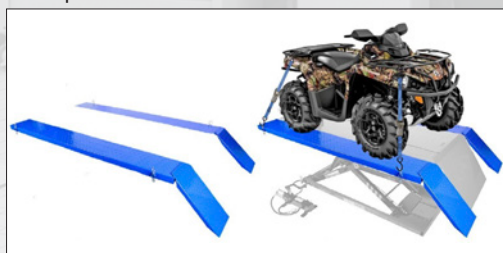

Not suitable for wider ATV's where wheel overhang is possible.

#### 9 Hazards and Obstructions.

All wheeled TQB Brands equipment must be used on smooth surface free of cracks, crevices and tripping hazards that can foul the wheels during operation or relocation.

#### 10 Storage

When not in use, the lift must be stowed in the lowest position in a dry location to minimize ram and piston corrosion.

#### 11 Read the user Manual thoroughly and

keep a copy easily accessible or visit our webpage [www.tqbbrands.com.au](http://www.tqbbrands.com.au) for instructional documents & pre-start videos.



# PRODUCT INFORMATION

## How to extend the life of your Hydraulic Motorcycle Lift

### 9 Top Tips

### to extend the life of your TradeQuip Hydraulic Motorcycle Lift Model 2101T

#### 1 Personal Safety

Correct PPE should always be worn whilst operating any Motorcycle Lift.



#### 2 Setting Up and Leveling the Lift

To ensure safe operation your TradeQuip Motorcycle Lift must be used on a flat level surface. The 2101T model has leveling adjusters that should be used in conjunction with a spirit level to achieve a safe level lift platform.



#### 3 Ensure Hydraulic Oil is at correct levels

Remove the filler bung and fill the reservoir with SAE 32 hydraulic oil to within 5mm to 10 mm below the filler hole. Replace the filler bung and test the jack throughout its entire stroke to ensure full stroke is achieved adding additional oil as required.

**Do Not Overfill.**



#### 4 Frame Pivots, Rollers, Wheels and Castors Lubrication

Wheels, Castors, Pivots, Pins and Rollers should be lubricated with a Light Bearing Grease or 30/40W Machine Oil to ensure long life, smooth operation and prevent premature wear.

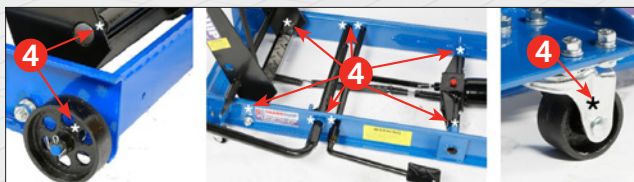

#### 5 Safety Locking Device

Your TradeQuip 2101T Motorcycle Lift comes with a Safety Device consisting of two pin holes per side of the lower rear fulcrum and the locking pin. For your safety this device must be used when any load is applied to the lift platform.



Raise to the desired height then insert the pin and operate the hydraulic release to take load onto the locking device assembly.

#### 6 Mounting Your Motorcycle

Do not use the leading plate to support the weight of the motorcycle when lifting. The leading plate is only used to assist with wheeling the motorcycle onto the platform when the lift is at its lowest level. Align the front or rear wheel within the wheel Jaws and close the Jaws until the motorcycle is held firmly in a vertical position.



#### 7 Hazards and Obstructions.

All wheeled TQB Brands equipment must be used on smooth surface free of cracks, crevices and tripping hazards that can foul the wheels during operation or relocation.

#### 8 Storage



When not in use, the lift must be stowed in the lowest position in a dry location to minimize ram and piston corrosion.

#### 9 Read the user Manual thoroughly and

keep a copy easily accessible or visit our webpage [www.tqbbrands.com.au](http://www.tqbbrands.com.au) for instructional documents & pre-start videos.



# PRODUCT INFORMATION

## How to extend the life of your Hydraulic Motorcycle Lift

### 9 Top Tips

### to extend the life of your TradeQuip Hydraulic Motorcycle Lift Model 2102T

#### 1 Personal Safety

Correct PPE should always be worn whilst operating any Motorcycle Lift.



#### 2 Setting Up and Leveling the Lift

To ensure safe operation your TradeQuip Motorcycle Lift must be used on a flat level surface. The 2102T model has stabilizing legs that should be used to achieve a safe, stable and level lift platform.

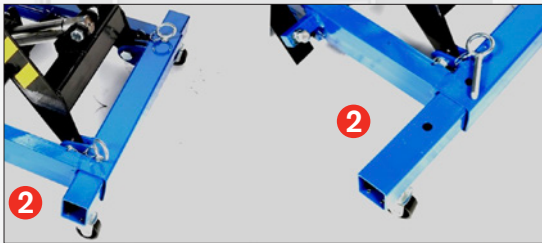

#### 3 Ensure Hydraulic Oil is at correct levels

Remove the filler bung and fill the reservoir with SAE 32 hydraulic oil to within 5mm to 10 mm below the filler hole. Replace the filler bung and test the jack throughout its entire stroke to ensure full stroke is achieved adding additional oil as required.

**Do Not Overfill.**



#### 4 Frame Pivots, Rollers, Wheels and Castors Lubrication

Wheels, Castors, Pivots, Pins and Rollers should be lubricated with a Light Bearing Grease or 30/40W Machine Oil to ensure long life, smooth operation and prevent premature wear

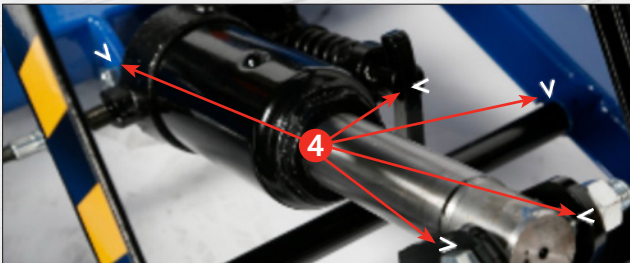

#### 5 Safety Locking Device

Your TradeQuip 2102T Motorcycle Lift comes with a Safety Height Locking device consisting of three pin holes per side of the table frame and a locking pin. For your safety this device must be used when any load is applied to the lift platform.



Raise to the desired height then insert the pin and operate the hydraulic release to take load onto the locking device assembly.

#### 6 Mounting Your Motorcycle

Do not use the leading plate to support the weight of the motorcycle when lifting. The leading plate is only used to assist with wheeling the motorcycle onto the platform when the lift is as its lowest level. Align the front or rear wheel within the wheel clamp Jaws and close the Jaws until the motorcycle is held firmly in a vertical position.



#### 7 Hazards and Obstructions.

All wheeled TQB Brands equipment must be used on smooth surface free of cracks, crevices and tripping hazards that can foul the wheels during operation or relocation.

#### 8 Storage

When not in use, the lift must be stowed in the lowest position in a dry location to minimize ram and piston corrosion.



9 Read the user Manual thoroughly and keep a copy easily accessible or visit our webpage [www.tqbbrands.com.au](http://www.tqbbrands.com.au) for instructional documents & pre-start videos.



# PRODUCT INFORMATION

## How to extend the life of your Auxiliary Motorcycle Lift

### 5 Top Tips

### to extend the life of your TradeQuip Auxiliary Motorcycle Lift Model 2104T



#### 1 Personal Safety

Correct PPE should always be worn whilst operating any Motorcycle Lift.



#### 2 Frame Pivots, Rollers, Wheels, and Screw Threads Lubrication

Wheels, Screw Threads Pivots, Pins and Rollers should be lubricated with a Light Bearing Grease or 30/40W Machine Oil to ensure long life, smooth operation and prevent premature wear.

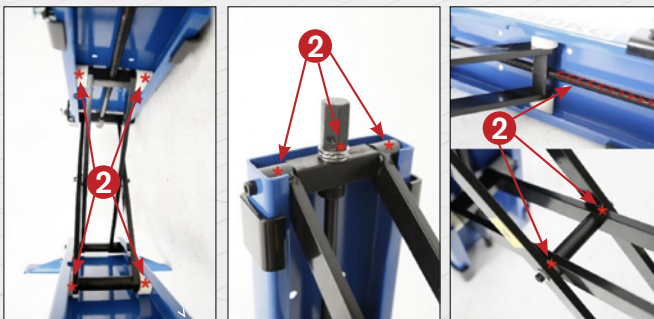

#### 3 Setting Up and Suspending Front or Rear Wheels Step 1

Once your motorcycle is securely mounted and wheel clamped on your main lift platform, place your motorcycle auxiliary lift under the motorcycle frame and adjust the two directional contact pads to the correct height and distance apart mating up with the factory recommended motorcycle lift points. Tighten the position locks then raise the auxiliary stand until adequate clearance is achieved between the main lift platform and the lower side of the wheel.



#### 4 Setting Up and Suspending Front or Rear Wheels Step 2

Re-check the wheel clamp then use adjustable load rated load restraint straps to secure the motorcycle to the platform.



#### 5 Read the user Manual thoroughly and keep a copy easily accessible or visit our webpage [www.tqbbrands.com.au](http://www.tqbbrands.com.au) for instructional documents & pre-start videos.



# PRODUCT INFORMATION

## How to extend the life of your Scissor Lift Workshop Trolley

### 9 Top Tips

to extend the life of your  
**TQB TradeQuip Scissor  
Lift Workshop Trolley**

Includes Models:  
6003T, 6007T,  
6008T, 6009T  
and 6010T

#### 1 Bleeding procedures.

To keep your TradeQuip Scissor Lift Workshop Trolley hydraulic power pack in good condition it will need to be bled periodically depending on usage. Bleeding procedures information can be found on our website at [www.tqbbrands.com.au](http://www.tqbbrands.com.au) Example below.

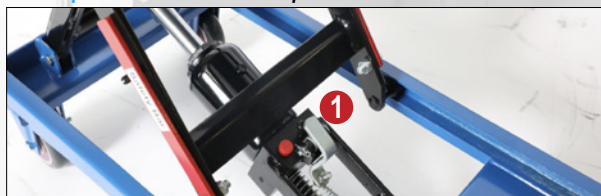

Before using this Hydraulic Scissor Lift Trolley, the hydraulic ram must be purged of air (called bleeding).

1. Remove any load from the Table.
2. Release the Control Lever (22), then repeatedly pump the Foot Pedal (27).
3. When the Table has been raised, remove the Filler Bung/Filler Bolt (P22) from the housing. Use a rag to catch any fluid leaks.
4. Keeping hands and tools clear, squeeze the Control Lever while pumping the Foot Pedal several times rapidly to lower the Table.
5. Release the Control Lever and pump more slowly to raise the Table to its full height.
6. Add good quality hydraulic fluid into the opening in the Housing where the Filler Bolt/Filler Bung has been removed. Fill until the Housing will hold no more fluid.
7. Replace the Filler Bung or if fitted with a Filler Bolt, install its Seal Washer into the Housing, tighten, but do not overtighten to avoid damaging the Washer.
8. Check the condition of the Hydraulic Lift Table before use. Raise and lower it several times before adding any load. Be sure that all controls work properly.

#### 2 Frame Pivoting Arms, Pins and Rollers.

Frame Pivoting Arms, Pins and Rollers should be lubricated with a Light Bearing Grease, 30/40W Machine Oil or Aerosol Lithium/Silicone Spray Grease to ensure long life, smooth operation and prevent premature wear.



#### 3 Wheels, Castors and Brake Mechanisms.

Wheels, Castors & Brake Mechanisms should be lubricated with a Light Bearing Grease, 30/40W Machine Oil or Aerosol Lithium/Silicone Spray Grease to ensure long life, smooth operation & prevent premature wear.



#### 4 Periodical Re-tensioning

Scissor Lift Workshop Trolley uses a cable connected release lever that may periodically require re-tensioning to limit free movement. Your model may have an adjuster at either end or one only. Check the release lever for free movement then to adjust, loosen the locking nut and wind the barrel counter clockwise until there is approx. 5mm of free movement in the lever. Re tighten the locking nut then load test the Scissor Lift for raising and holding ability. Re-adjust if necessary. For relevant model instructions check your model specific owner's manual with your product on online at [www.tqbbrands.com.au](http://www.tqbbrands.com.au)

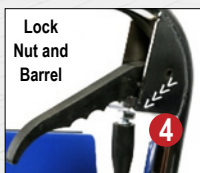

#### 5 Safety Locking Device Applicable to 6008T, 6009T and 6010T Trolleys

Your TradeQuip 6008T/9T/10T Scissor Lift Trolley comes with a Safety Height Locking device consisting of two fold down locking bars that are folded into the lower frame to lock the Scissor mechanism into place.

For your safety this device must be used when any load is applied to the lift platform for extended time frames.

Raise to the desired height then fold both locking bars into the lock position and operate the hydraulic release to take load onto the locking device assembly.

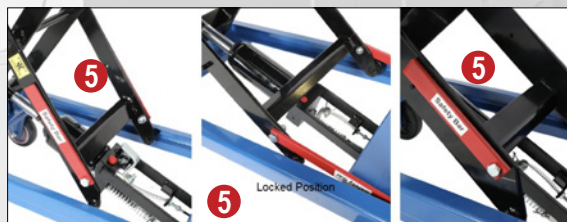

#### 6 Storage when not in use.

When not in use, the lift must be stowed in the lowest position in a dry location to minimize ram and piston corrosion.



#### 7 Hazards and Obstructions.

All wheeled TQB Brands equipment must be used on smooth surface free of cracks, crevices and tripping hazards that can foul the wheels during operation or relocation.

#### 8 Hydraulic system bleeding instructions.

For hydraulic system bleeding instructions please visit [www.tqbbrands.com.au](http://www.tqbbrands.com.au) for TradeQuip Scissor Lift Workshop Trolley user manual downloads.

#### 9 Read the users Manual thoroughly and keep a copy easily accessible.

Read the users Manual thoroughly & keep a copy easily accessible or visit our webpage at [www.tqbbrands.com.au](http://www.tqbbrands.com.au) for instructional documents & pre-start videos.

**TQB**  
TQB Brands Pty Ltd



# PRODUCT INFORMATION

## How to extend the life of your Tradequip & Borum Vices

### 9 Top Tips

to extend the life of your Tradequip & Borum Vices

Models  
7000T, 7001T, 7002T,  
7003T, 7004T, 7005T,  
7007T, 7009T,  
BRV150, BRV200

#### 1 Rated Capacity

Rated capacity is an important factor when choosing the right vice for your application, exceeding rated capacity can cause damage to your vice body, threaded rod, and jaws. Use the chart below to consider the right vice for your application.

TQB Code	Width of Jaw (mm)	Max. Opening (mm)	Throat Depth (mm)	Clamping Force (kn)
7000T	125	130	69	15
7001T	150	150	76	20
7002T	200	170	88	25
7003T	125	140	76	25
7004T	150	170	86	29
7005T	200	220	110	40
7007T	150	140	103	50
7009T	150	140	80	30
BRV150	150	140	95	25
BRV200	200	170	110	30

#### 2 Correct mounting on a level surface is critical to providing best results from your Vice

A general rule of thumb when mounting a vice is the entire circumference of the base must be in contact with the bench top and the non-moving jaw face must not overhang the bench edge by more than 5mm.

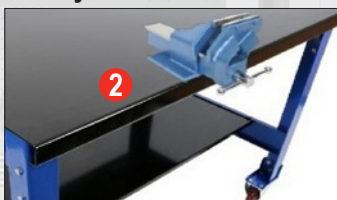

#### 3 Vice Handles are designed at a pre-determined length to prevent exceeding the Clamping Force of a Vice

Exceeding this length by means of an extension will multiply the clamping force beyond the design capabilities of the vice and cause breakages, where higher clamping force is required, we recommend you choose a vice with a higher rated clamping force.



#### 4 Do Not Exceed Clamping Force

A vice's clamping force is at its highest when clamping in the centre of the jaw set, we recommend that when holding awkward shaped items towards the jaw face ends that less force is to be applied through the handle. Where a workpiece to be held must be clamped in an "off set" position but is still loose, we recommend you move the item closer to the jaw centre point or choose a vice with higher clamping force capacity.



#### 5 Vibration Limitation Recommended

The work holding ability of the TQB Brands vice range relies on minimising vibration that may cause failure of the vice jaws to hold the work piece, we recommend limiting vibration by using hand applied torque devices such as breaker bars, excess vibration from tools such as impact wrenches cause work holding slippage resulting in damage to the vice, workpiece and or operator.

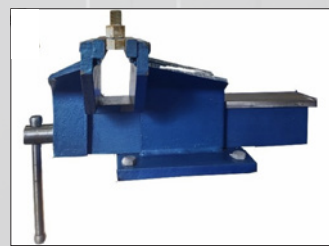
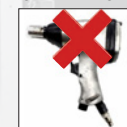

#### 6 Safety

TQB Brands Bench Vices are "Not Designed to be used as Suspension Spring Compression Tools" where over loading & lack of safety restraints can cause damage to the vice and or operator.

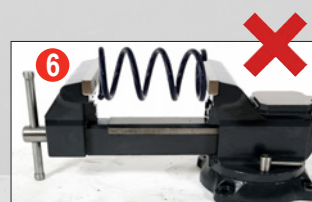

#### 7 Safety

TQB Brands Bench Vices are "Not Designed to be Used" for Bearing, Sleeve or Bush pressing jobs where higher and multiplying force over distance is required.



#### 8 Vices Require Lubrication

Vices require lubrication to minimise the effects of friction to perform as per manufacturers specifications. Friction caused by lack of lubrication can cause premature wear of moving parts and reduce applicable clamping force. Lubrication should be applied to the moving parts as indicated below to ensure longer life and ease of operation.



Our range of Tradequip & Borum Industrial Vices have been manufactured to exacting standards. We specify industrial quality components and design to ensure a long and durable working life in commercial transport, mining, earthmoving, and railway environments. Our Borum Industrial range of equipment is focused on achieving superior professional standards, reliability, quality, and are covered by a 12-month trade use warranty.

#### 9 Read the user Manual thoroughly and keep a copy easily accessible or visit our webpage [www.tqbbrands.com.au](http://www.tqbbrands.com.au) for instructional documents & pre-start videos.



# PRODUCT INFORMATION

## How to extend the life of your Tradequip Wheel & Tyre Lifter

### *10 Top Tips*

### to extend the life of your Tradequip Wheel and Tyre Lifter

- 1** Ensure all assembly bolts and fasteners are positioned correctly and tightened before use.

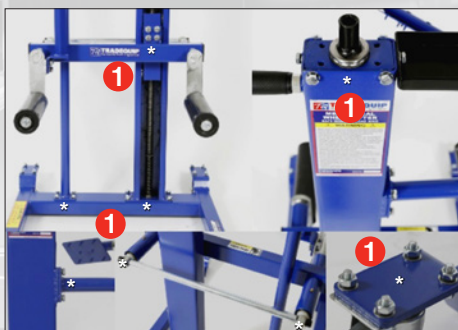

- 2** Regularly lubricate all castors and wheels for ease of movement once loaded.



- 3** Regularly lubricate the lift Screw, Thrust Washer and Roller Shuttle Assembly.

Use a light spray grease and a light grease via the grease nipple for the Extension Slides to ensure smooth operation while raising and lowering the load.

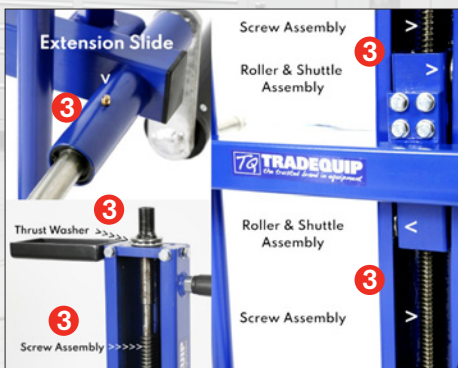

- 4** Regular cleaning recommended.

Regular cleaning of the lift Screw, Thrust Washer and Roller Shuttle Assembly is recommended where used outdoors or in dirty environments. We recommend using an aerosol degreaser liberally sprayed over all components then low pressure rinse avoiding labels and dry then reapply a grease [tip 3].

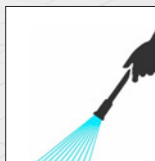

- 5** Safe operation of your Wheel Tyre Lifter. To ensure safe operation of your Wheel Tyre Lifter whilst under load, always make sure the roller legs are at 90 degrees to the vehicle wheel and the wheel safety clamp is correctly positioned to allow for smooth operation while raising, lowering, and relocating the wheel.



- 6** Safety Loading. Tyre width and weight are important factors to consider when using your Tradequip Wheel / Tyre Lifter.

For your safety you should not exceed the 50Kg Load Rating, 300mm Maximum tyre width.

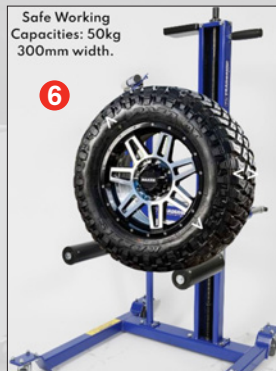

- 7** Raising and Lowering of the Lifter.

Is accomplished by engaging a 1/2" drive tool with the 1/2" drive socket at the top of the main upright. The drive tool can be a 1/2" air impact gun or 1/2" rechargeable impact gun. Operating the drive tool in a clockwise direction will raise the lift rack assembly and operating in reverse will lower the lift rack.



- 8** Hazards and Obstructions.

All wheeled TQB Brands equipment must be used on smooth surface free of cracks, crevices and tripping hazards that can foul the wheels during operation or relocation.

- 9** Correct storage is vital for longevity.

Always store the Wheel/Tyre Lifter in a dry dust free area to minimise corrosion and keep the worm drive and lift rack assembly clean.

- 10** Read the user Manual thoroughly and keep a copy easily accessible or visit our webpage [www.tqbbrands.com.au](http://www.tqbbrands.com.au) for instructional documents & pre-start videos.