

# TQ Pro

Trusted by serious professionals

## OWNERS MANUAL

20,000KG  
AIR ACTUATED

# BOTTLE JACK



**Professional  
Reputable  
Outstanding**

+ STRONG  
 + PRECISE  
 + RELIABLE  
 + WELL FINISHED

**TQ Pro**  
 Trusted by serious professionals

LATEST APPLIED  
 TECHNOLOGIES

**About the TQ Pro brand**

TQ Pro top quality Tools and Equipment are designed and manufactured for specialist *professional use in a garage and workshop* environment. TQ Pro products are strong, reliable, and well finished for the expert tool user who appreciates professional design, reliability, and attention to detail. Covered by our *12month trade use warranty*, our TQ Pro Tools & Equipment are made with pride to deliver the best combination of professional performance, presentation, and reliability.

Working Load Limit	Minimum Lift Height	Maximum Lift Height	Hydraulic Lift	Air Pressure Range	Air Inlet Fitting
20,000kg	185mm	330mm	80mm	110-125psi	¼" NPT

# WARNING INFORMATION

## IMPORTANT: READ ALL INSTRUCTIONS BEFORE USE



### WARNING

The instructions and warnings contained in this manual should be read and understood before using or operating this equipment. Do not allow anyone to use or operate this equipment until they have read this manual and have developed a thorough understanding of how this equipment works. Failure to observe any of the instructions contained in the manual could result in severe personal injury to the user or bystanders, or cause damage to the equipment and property. Keep this manual in a convenient and safe place for future reference.

Whilst every effort has been made to ensure accuracy of information contained in this manual, the **TQ Pro** policy of continuous improvement determines the right to make modifications without prior warning.

# CONTENT

WARNING INFORMATION.....	2
CONTENT .....	2
SAFETY INSTRUCTIONS.....	3
ASSEMBLY, OPERATION & PREVENTATIVE MAINTENANCE.....	4
PARTS LIST .....	7
TROUBLESHOOTING.....	8
WARRANTY .....	9
TOP TIPS.....	10

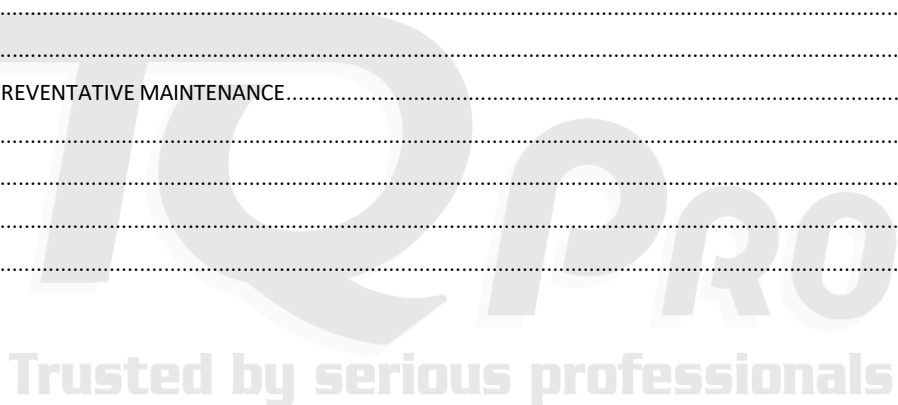

*TQ Pro top quality Tools and Equipment are designed and manufactured for specialist professional use in a garage and workshop environment. TQ Pro products are strong, reliable, and well finished for the expert tool user who appreciates professional design, reliability, and attention to detail. Covered by our 12 month trade use warranty, our TQ Pro Tools & Equipment are made with pride to deliver the best combination of professional performance, presentation, and reliability.*



## SAFETY INSTRUCTIONS



Safety glasses must be worn when operating this equipment



Safety footwear must be worn when operating this equipment



Rings and jewellery must not be worn when operating this equipment



Long loose hair must be contained when operating this equipment



Close fitting/protective clothing must be worn when operating this equipment



### PRE-OPERATIONAL SAFETY CHECKS

- Check vehicle owner's manual for correct vehicle weight and jacking points.
- Do not exceed the safe working load limit listed on the jack.
- Use only on a hard, flat, level surface that will sustain the vehicle weight.
- Apply the vehicle parking brake and securely chock wheels remaining on the ground.
- Inspect the jack prior to every use and do not use if parts are worn or jack is damaged.
- Lift only under an appropriate strong position on the vehicle, as specified in the vehicle owner's manual.
- Centre the load prior to lifting and do not move or dolly the vehicle whilst on this jack.
- The jack is a lifting device only. Immediately after lifting, support the vehicle with AS Approved jack stands.
- Do not use this jack for any purpose other than specified by this owner's manual.
- Do not modify this jack and do not use this jack for a purpose for which it was not intended.



### POTENTIAL HAZARDS

- User does not read, understand and follow the instructions and warnings in this manual prior to operating the jack.
- Work area is not well lit or kept clean and tidy.
- Vehicle load is not immediately supported on AS Approved jack stands prior to commencing work on or under vehicle.
- Not maintaining or servicing this jack to the manufacturer's recommendations.
- Making unauthorised modifications to this jack.

### INTENDED USE

For heavy duty truck, agriculture, construction, mining, mobile home, oil field, automotive, and marine applications where lifting is required.



## WARNING



**ENSURE WHEELS ARE CHOCKED BEFORE LIFTING. ENSURE JACK IS USED ON A HARD LEVEL SURFACE THAT CAN HOLD THE WEIGHT. ENSURE THE LOAD IS CENTRALLY LOCATED ON THE HEAD CAP. CONSULT THE VEHICLE MANUFACTURER OWNERS MANUAL PRIOR TO LIFTING THE VEHICLE TO ENSURE THE CORRECT LIFT POINT SPECIFIED BY THE VEHICLE MANUFACTURER IS USED. THIS IS A LIFTING AND LOWERING DEVICE ONLY AND IS DESIGNED FOR LIFTING PART OF THE TOTAL VEHICLE. DO NOT MOVE OR DOLLY THE VEHICLE WHILST THE VEHICLE IS ON THE JACK.**

## ASSEMBLY, OPERATION & PREVENTATIVE MAINTENANCE

### 1. FEATURES

The **TQ Pro** Air Actuated Hydraulic Bottle Jack is designed to operate either manually or pneumatically for lifting and lowering, but not sustaining load. This 20,000kg Heavy-Duty Air/Hydraulic Bottle Jack is the perfect choice for a wide variety of uses. The power of air makes it easy to lift farm vehicles, trucks, lawn mowers, heavy equipment and other large loads. The manual function allows for normal operation anywhere, even without an air supply.

### 2. BEFORE USE

Conduct a thorough visual inspection checking for any abnormal conditions, such as cracked welds, and damaged, loose, or missing parts. Bleed any trapped air from the hydraulic system by performing the air bleeding procedure below.

#### Bleed Air from Hydraulic System:

During transit the unit may become "air-bound", causing a spongy ram action. To bleed the hydraulic system;

- Remove the Oil Filler Bung and if required, refill with \*32 Grade hydraulic oil until the oil is lapping the bottom of the Oil Filler Hole then replace the Oil Filler Bung.
- Start with the Pump Socket Assembly in the horizontal position and turn the Release Valve 'clockwise' to the lifting position.
- With the Jack on its base, pull the Pump Socket upwards to the raised position.
- Invert the Jack and push the Pump Socket back to the horizontal position.
- Place the Jack back on its base to test the Pump Socket for firmness.
- Repeat steps 4 to 6 until the Pump Socket feels firm and the Lift Ram is extending consistently.
- At this point the Pump Assembly should be bled of air.
- Follow steps 8 to 9 to bleed the Lift Ram.
- Ensure the Jack is back on its base and make sure the Release Valve is in the 'clockwise' raise mode, then pump the Pump Socket until the Lift Ram is fully extended.
- Invert the Jack and then turn the Release Valve 'anti-clockwise' to the lowering position. Carefully hold the Jack in the inverted position until the Lift Ram is fully retracted. If necessary apply force to the bottom of the Jack to return the Lift Ram back to fully retracted position.

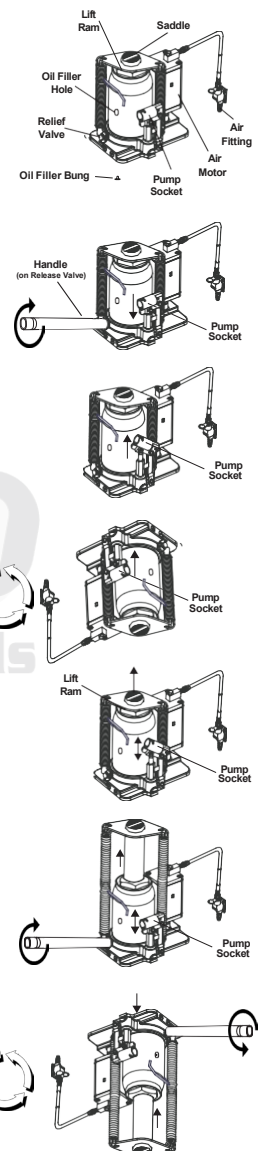

**At this point both the Manual Pump and Lift Ram should now be free of air and the Jack ready for Air Motor bleeding (See Below).**

**Bleed Air for Air Motor:**

1. Remove the Oil Filler Bung and if required, refill with \*32 Grade hydraulic oil until the oil is lapping the bottom of the Oil Filler Hole.
2. Leave the Oil Filler Bung out, turn the Release Valve 'clockwise' to the lift position and pump the Pump Socket 'up and down' to raise the Lift Ram to full extension.
3. Replace the Oil Filler Bung, then turn the Release Valve 'anticlockwise' to the lowering position until the Lift Ram returns to the fully lowered position.  
(Note: Depress the Saddle where necessary)
4. Turn the Release Valve 'clockwise' to the raise position. Connect an air supply to the Air Trigger assembly and depress the trigger, holding down until the Lift Ram is fully extended.
5. Remove the Oil Filler Bung, then turn the Release Valve 'anticlockwise' to the lowering position until the Lift Ram returns to the fully lowered position.  
(Note: Depress the Saddle where necessary)
6. Replace the Filler Bung and turn the Release Valve 'clockwise' to the raise position. Connect an air supply to the Air Trigger assembly and depress the trigger, holding down until the Lift Ram has extended to full stroke then...  
**...continue to hold the trigger down for 10 seconds.**
7. Turn the Release Valve 'anticlockwise' to the lowering position until the Lift Ram returns to the fully lowered position. (Note: Depress the Saddle where necessary)

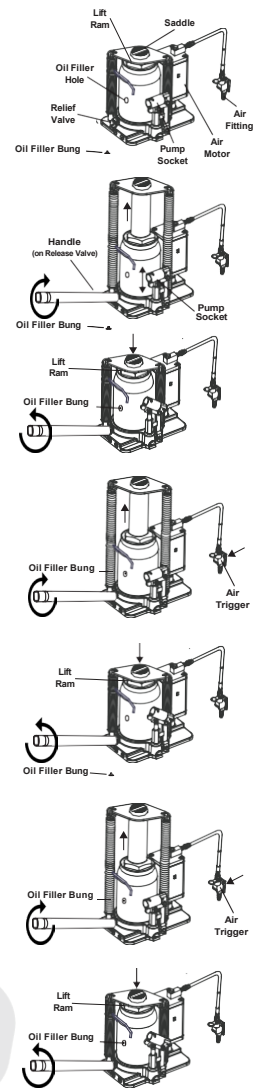

**At this point the Manual Pump, Air Motor Pump and Lift Ram should be free of air and the Jack ready for Operation.  
If the Jack continues to show the Symptoms as above, please refer to a Qualified Hydraulic Technician.**

**3. OPERATION**

Prior to each use always conduct a visual inspection checking for and any abnormal conditions, such as cracked welds, and damaged, loose, or missing parts.

**Raising the Jack:**

1. Block the vehicle's wheels for lifting stability. Secure the load to prevent inadvertent shifting and movement.
2. Position the jack near desired lift point.
3. Set the parking brake in the vehicle.
4. Refer to the vehicle manufacturer owner's manual to locate approved lifting points on the vehicle. Position the jack so the saddle is centred and will contact the load lifting point firmly
5. Assemble the handle; ensure that spring clips align with slots.
6. Close the release valve by turning it clockwise until it is firmly closed.
7. Insert and secure the handle into handle sleeve. Pump handle or squeeze the lift control valve until the saddle contacts load. To end air operation simply release the grip on the lift control valve.
8. Raise load to the desired height, then immediately transfer the load to appropriately rated jack stands.

**⚠ WARNING**

Never wire, clamp or otherwise disable the lift control valve to function by any means other than by using the operator's hand. Use the handle provided with this product or an authorised replacement handle to ensure proper release valve operation. Do not use extensions on the air hose or on the operating handle.



**To Lower Vehicle:**

1. Raise load high enough to allow clearance for the jack stands to be removed, then carefully remove jack stands.
2. Insert handle release valve and slowly turn handle counter clockwise, no more than 1/2 a turn.
3. Grasp the handle firmly with both hands. Securely hold on to the jack handle so your hands do not slip and ensure the load does not rapidly lower.
4. (Do not allow bystanders around the jack or under the load when lowering the jack).

**4. MAINTENANCE**

If you use and maintain your equipment properly, it will give you many years of service. Follow the maintenance instructions carefully to keep your equipment in good working condition. Never perform any maintenance on the equipment while it is under a load.

**Inspection:** Inspect the product for damage, wear, broken or missing parts (eg: pins) and that all components function before each use. Follow lubrication and storage instructions for optimum product performance. Ensure all moving parts are clear of dirt and debris.

**Cleaning:** If the moving parts of the equipment are obstructed, use cleaning solvent or another good degreaser to clean the equipment. Remove any existing rust, with a penetrating lubricant.

**Lubrication:** This equipment will not operate safely without proper lubrication. Using the equipment without proper lubrication will result in poor performance and damage to the equipment. A coating of light lubricating oil to pivot points, axles and hinges will help to prevent rust. Periodically check the pump piston and ram for signs of rust or corrosion. Clean as needed and wipe with an oily cloth.

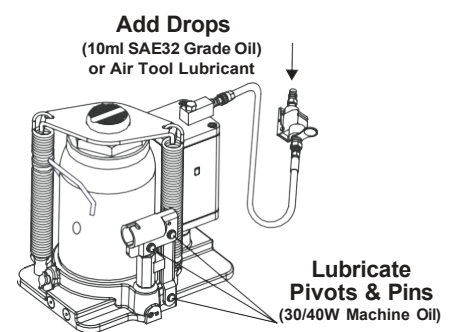

**NEVER USE SANDPAPER OR ABRASIVE MATERIAL ON THESE SURFACES.**

**To Add Jack Oil:**

NEVER USE BRAKE FLUID, TURBINE OIL, TRANSMISSION FLUID, MOTOR OIL OR GLYCERIN. IMPROPER FLUID WILL CAUSE PREMATURE FAILURE OF THE JACK AND THE POTENTIAL FOR SUDDEN OR IMMEDIATE LOSS OF LOAD

1. With saddle fully lowered and pump piston fully depressed, set jack in its upright level position.
2. Remove oil filler plug.
3. Fill until oil is level with the filler plug hole, reinstall oil filler plug.

**Replace Jack Oil:**

For best performance and longest life, replace the complete fluid supply at least once per year.

1. With the saddle fully lowered and pump piston fully depressed, remove the oil filler plug.
2. Lay jack on its side and drain the fluid into a suitable container.
3. Fill the oil case until oil level is just beneath the lower rim. KEEP DIRT AND OTHER MATERIAL CLEAR WHEN POURING.
4. Replace oil plug.
5. Perform air bleeding procedure.

**5. SERVICE & REPAIR**

Any **TQ Pro** Bottle Jack found damaged in any way, or found to be worn or operates abnormally should be removed from service until repaired by an authorised service agent. Owners and / or operators should be aware that repair of this product may require specialised equipment and knowledge. Only authorised parts, labels, decals shall be used on this equipment. Annual inspection of the Bottle Jacks is recommended and can be made by an authorised repair facility to ensure that your equipment is in optimum condition and that the equipment has the correct decals and safety labels specified by the manufacturer.

## PARTS LIST

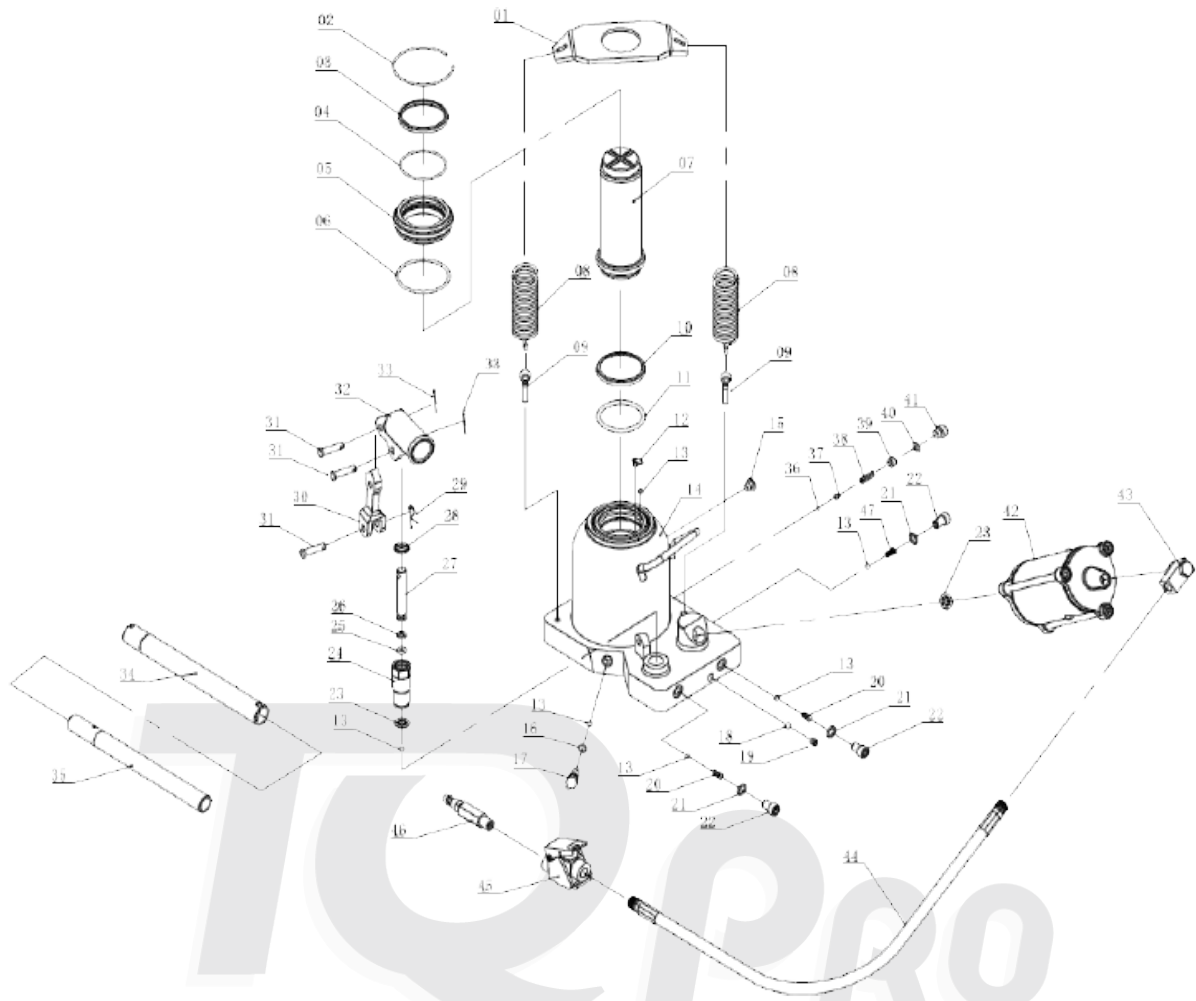

Part	Description	Qty
1	Spring Plate	1
2	Retaining Ring	1
3	Dust Ring	1
4	O-Ring	1
5	Limiting Ring	2
6	O-Ring	1
7	Piston Rod Assembly	1
8	Spring	2
9	Adjustable Bolt	2
10	Washer	1
11	O-Ring	1
12	Shield	1
13	Steel Ball	6
14	Welded Pump Assembly	1
15	Filler Plug	1
16	O-Ring	1
17	Screw	1
18	Steel Ball	1
19	Screw	1
20	Spring	2
21	Copper Washer	3
22	Screw	3
23	Copper Washer	2
24	Pump Core Seat	1

Part	Description	Qty
25	O-Ring	1
26	PTFE	1
27	Pump Core	1
28	Dust Ring	1
29	R-Pin	1
30	Connecting Rod	1
31	Pin	3
32	Handle Socket	1
33	Cotter Pin	2
34	Handle - 1	1
35	Handle - 2	1
36	Steel Ball	1
37	Steel Ball Seat	1
38	Spring	1
39	Screw	1
40	O-Ring	1
41	Screw	1
42	Air Motor	1
43	Rotary Joint	1
44	Air Hose	1
45	Air Valve	1
46	Hose Connector	1
47	Spring	1

## TROUBLESHOOTING

Problem	Symptom	Cause	Conclusion	Solution
Jack will not lift using manual pump	Manual pump has no resistance, lift ram will not raise	Release valve not tightly closed	Bypass through release valve	Ensure release valve tightly closed
		Air in hydraulic system	Air cavitation in pump and/or lift ram	Bleed system
		Load weight exceeds lift capacity	Higher capacity jack required	Select higher capacity jack
		Overload actuated	Relief valve needs reset	Contact qualified technician for repairs
Jack Will Not Lift using Air pump	Air Pump operating but lift ram will not raise	Release valve not tightly closed	Bypass through release valve	Ensure release valve tightly closed
		Air in hydraulic system	Air cavitation in pump and/or lift ram	Bleed system
		Load weight exceeds lift capacity	Higher capacity jack required	Select higher capacity jack
		Overload actuated	Relief valve needs reset	Contact qualified technician for repairs
		Air Motor effected by water in air supply. Air exhausting but motor not pumping.	Lubrication flushed out of air motor, requires added lubrication.  Adding lubrication to air motor fails to remedy issue.	Install air /water separator to air supply.  Follow Lubrication instructions.
Jack will not hold load	Load cannot be sustained, lift ram drops under load	Release valve not tightly closed	Bypass through release valve	Ensure release valve tightly closed
	Pump handle rises	Damaged main seal  Main check valve obstructed	Replace main ram seals  Replace main check valve ball and reseal valve seat	Contact qualified technician for repairs
Jack will not lower after unloading	Ram rises after retracting	Reservoir overfilled	Pump failure due to cavitation caused by excess reservoir level	Drain fluid to proper level
	Release valve pin seized	Linkages binding	Dry release valve pin	Lubricate release valve with 32grade hydraulic oil



Poor lift performance	Pump has no resistance, lift ram will not raise to full stroke	Fluid level low  Air trapped in system	Fill fluid to correct level  Lift ram raised for extended period causing air ingress to hydraulic system	Fill fluid to correct fluid level and bleed system  With ram fully retracted, remove oil filler plug to let pressurised air escape reinstall oil filler plug then bleed system
Will not lift to full extension	Lift ram has limited stroke, pump loses resistance	Fluid level low	Lift ram raised for extended period causing air ingress to hydraulic system	Fill fluid to correct level then bleed system

## WARRANTY

**TQ Pro** products have been carefully tested and inspected before shipment and are guaranteed to be free from defective materials and workmanship for a period of 12 months from the date of purchase except where tools are hired out when the guarantee period is ninety days from the date of purchase.

Should the machine develop any fault, please return the complete tool to your nearest authorised warranty repair agent or contact TQB Brands Pty Ltd Warranty team – [warranty@tqbbrands.com.au](mailto:warranty@tqbbrands.com.au).

If upon inspection it is found that the fault occurring is due to defective materials or workmanship, repairs will be carried out free of charge. This guarantee does not apply to normal wear and tear, nor does it cover any damage caused by misuse, careless or unsafe handling, alterations, accident, or repairs attempted or made by any personnel other than the authorised TQB Brands Pty Ltd repair agent.

This guarantee applies in lieu of any other guarantee expressed or implied and variations of its terms are not authorised.

Your TQB Brands Pty Ltd guarantee is not effective unless you can produce upon request a dated receipt or invoice to verify your proof of purchase within the 12 month period.

### Consumer Guarantee

Our goods come with a guarantee that cannot be excluded under the Australian Consumer Law. You are entitled to a replacement or refund for a major failure and compensation for any other reasonably foreseeable loss or damage. You are also entitled to have the goods repaired or replaced if the goods fail to be of acceptable quality and the failure does not amount to a major failure.



All images and illustrations shown are for reference purposes only. All information, specifications and illustrations in this manual are based on the latest information available at the time of publication and are subject to change without notice. The information in this manual is periodically revised to ensure the latest information is included. Download the latest version of this manual and other related technical documentation from [www.tqbbrands.com.au](http://www.tqbbrands.com.au)

# PRODUCT INFORMATION

## How to extend the life of your Bottle Jacks

### 8 Top Tips

### to extend the life of your TQB BRANDS Manual & Air/Manual Bottle Jacks

**1 Ensure Hydraulic oil is at correct levels.**

Follow individual model owner's manual instructions for maintenance in your owner's manual provided and also available on our webpage at [www.tqbbrands.com.au](http://www.tqbbrands.com.au)



Remove Filter Plug and refill with SAE 32 grade Hydraulic Oil to the level indicated.

**2 Regularly lubricate the Air motor and Manual Pump Pivots.**

Lubrication of the air motor and manual pump pivots, pins, is essential for smooth operation while raising a vehicle.

10ml SAE 32 grade Oil or Air Tool Lubricant.



Lubricate Pivots and Pins with 30/40W Machine Oil.

**3 Always store in the fully lowered position.**

Storage in the lowered position ensures the lift ram assembly and pump piston is sealed from exposure to weather fluctuations and keeps the hydraulic ram and pump seals in a relaxed condition ready to work when required.



**4 Never use bottle jack for supporting loads.**

To ensure long life of the hydraulic lift ram seals, a load must not be supported above the fully lowered position. Once a vehicle is raised it must be supported with a load appropriate vehicle stand with the jack lowered and not supporting load.

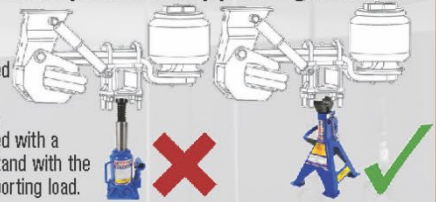

**5 Use the available screw extension or solid extension inserts where applicable.**

Single piston and multi piston telescopic jacks have their greatest stability from the fully lowered height to 85% of total extended height. Where the lowered height of the jack is lower than the load point height from the ground the extension screws and or solid extension inserts should always be used to close the clearance between jack and load point, this also greatly reduces the potential of lateral force.



**6 Off centre loading or unbalanced loads can affect the smooth lowering & raising operation.**

Always consult your vehicle manufacturer specifications for the correct lift point. Never lift from a suspension pivot or air bag mount plate where these items are designed to travel in an arc causing excess lateral force to the jack throughout its lift cycle.

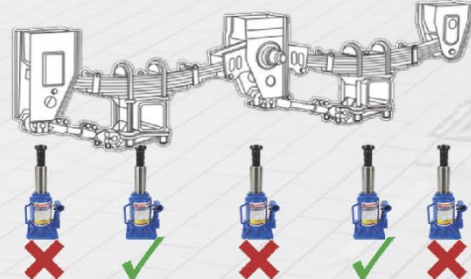
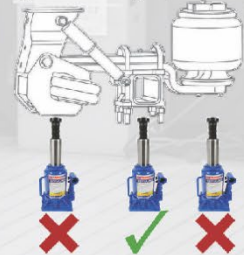

**7 Read the user Manual thoroughly and keep a copy easily accessible.**

**8 Visit our webpage [www.tqbbrands.com.au](http://www.tqbbrands.com.au) for instructional & pre-start video.**

